

NEW POINT OF VIEW

UPDATE

biba
SALOTTI

Biba Salotti fondata nel 1980 da Francesco Miari è un'azienda italiana affermata nel settore degli imbottiti di design.

La filosofia che caratterizza l'azienda è quella dell'artigianalità made in italy.

Ogni prodotto nasce con originalità, si sviluppa con passione e viene prodotto con standard di qualità altissimi.

Biba Salotti considera la ricerca e la sperimentazione un elemento strategico nella politica di sviluppo aziendale.

I prodotti Biba Salotti vengono realizzati nella sede aziendale situata a Parma, un'azienda che si estende su un'area di 23000 mq di cui 10000 mq sono adibiti alla produzione.

Tutti gli imbottiti vengono realizzati con materiali selezionati che garantiscono l'alta qualità, confermando Biba Salotti un marchio riconosciuto in Europa, America e Medio Oriente e Asia.

Biba Salotti was founded in 1980 by Francesco Miari. It is an Italian company, successful in the sector of soft furnishings.

The philosophy that characterises the company is craftsmanship MADE IN ITALY.

Each product is created with originality, is developed with passion and is reproduced with exceptionally high quality standards.

Biba Salotti considers research and experimentation to be a strategic element in the company's development.

Biba Salotti products are created at the company headquarters in Parma, a facility that covers an area of 23,000 square metres, 10,000 of which are used for production.

All the soft furnishings are made from selected materials that guarantee the high quality, ensuring that Biba Salotti is a brand recognised in Europe, America, Middle East and Asia.

biba
S A L O T T I



—



INDICE

INDEX

ADELAIDE	180	MAX	136
AGADIR	214	NICK	072
AIRON	218	NINNA	234
ALEX	124	NANNA	235
ALTEA	188	NOAH	082
AVATAR	140	OTTO	228
BELLO	084	PIUMA	200
BIPLANO	034	PLANO	182
BON BON	112	PLAY	144
BON TON	110	PONTE	050
BOSTON	158	PUFFO	117
BRAD	172	PUFFO LINE	117
BRAVO	038	RALPH	204
CHARLIE	164	SETTE	226
CLORINNE	198	SURF	224
DIECI	230	SILVER	052
DISCOVERY	114	TAG	070
EGO	208	TRIS	051
FREEDOM	006	WILLY	199
FROG	098	WIND	022
HOLÀ	222	ZENO	128
JOY	118	ZIP	016
LINK	102	<hr/>	
MADISON	232	I MATERIALI	236
MASTER	152	SCHEDE TECNICHE	242

FREEDOM

Voglia di libertà e voglia di condivisione. Il design diventa strumento di comunicazione personale.

Freedom è un progetto coinvolgente con un dna creativo 100% made in italy: ampie sedute per non avere limiti di movimento e molteplici composizioni per assecondare un'indole aperta e vivace.

A desire for freedom and a desire to share: design becomes a personal communication tool. Freedom is an engaging design with a 100% made in italy dna: wide seats that give room for movement and multiple compositions to indulge an open, lively nature.











ZIP

Energia, entusiasmo e sorprendente versatilità disegnano il carattere assolutamente originale di Zip.

La cerniera è il dettaglio estetico che interviene nel gioco degli abbinamenti cromatici, ed è anche parte integrante dell'aspetto funzionale agevolando la sfoderabilità del prodotto.

Energy, enthusiasm and unexpected versatility draw the absolutely original character of Zip. The zipper is the aesthetic detail that create a game of color combinations, and it is also an essential part of the functional aspect, simplifying the cover removal of the product.





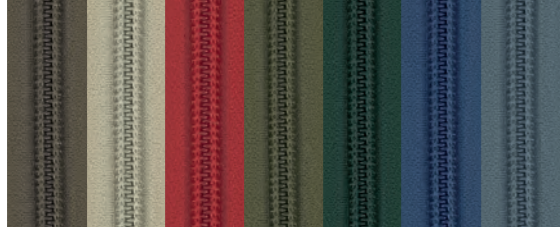

564 572 519 565 890 558 575

LA SCELTA DEI COLORI
PER CERNIERA E CUSCINO
NE DETERMINA IL MOOD
DI APPARTENENZA.

*The choice of colors for zipper and cushion
defines the belonging mood.*



WIND

Lasciarsi avvolgere da volumi capaci di accoglierci con rassicurante comfort è finalmente possibile. Il bracciolo e lo schienale si muovono, assecondano la posizione che vogliamo assumere; l'ergonomia delle forme e il sostegno dei materiali convivono in perfetta armonia.

Being enveloped by volumes capable of welcoming us with reassuring comfort is finally possible. The armrest and the backrest can move, following the pose we want to strike; the ergonomics of the shapes and the support of materials coexist in perfect harmony.









NUOVA ESPRESSIVITÀ
NELLA VERSIONE CON
SCHIENALI PRIVI DI
CUCITURE DECORATIVE.

*new expressiveness in the version
with backs without decorative seams.*





BIPLANO

Legno oppure tinte laccate per il top; vetro retroverniciato per il ripiano e metallo per la struttura: l'equilibrio estetico è nell'armonia dei materiali.

Wood or lacquered colors for the top; back-painted glass for the shelf and metal for the structure: the aesthetic balance is in harmony of the materials.



FORME ESSENZIALI
IN MISURE DIVERSE
COMPONGONO
ARCHITETTURE SENZA
SPIGOLI, RAFFINATE ED
ECLETTICHE.

*Essential shapes in different sizes compose
architectures without edges, sophisticated and
eclectic.*



BR A V O

Ci piace il sogno in tutta la sua spontaneità e la realtà in tutta la sua complessità.
Ci piace l'immaginazione e la sorpresa nel mettere insieme le cose.
Bravo dà forma e volume ad un progetto da osservare da diverse prospettive: il bracciolo disegna un profilo inedito e i cuscini definiscono i volumi accoglienti.

*We love dreams in all their spontaneity and reality in all its complexity.
We love imagination and surprising ways of putting things together.
Bravo give shapes and volume to a design to be looked at from different perspectives: the arm forms an unusual profile and the cushions define welcoming volumes.*















Tris e Ponte sono progetti ricchi di significato estetico e valore funzionale, capaci di trovare nuova espressione nel vivere quotidiano.

Tris and Ponte are projects rich of aesthetic meaning and functional value, capable of finding new expression in everyday life.



SILVER

LIGHT



Massima libertà compositiva per creare spazi
che si modificano velocemente.
Luoghi confortevoli destinati ai momenti di
convivialità e di relax.

*Maximum freedom of composition to create
spaces that change quickly.
Comfortable places destined for moments of
conviviality and relaxation.*





SILVER

Alla scoperta della dimensione più creativa di un progetto che appare sorprendentemente dinamico e confortevole.
Light o large: l'aspetto estetico cambia con la scelta del bracciolo nella larghezza che si preferisce.

*Discovering the most creative dimension of a project that seems unexpectedly dynamic and comfortable.
Light or large: the aesthetic aspect changes with the choice of the armrest's width you prefer.*





L'uomo contemporaneo ha il desiderio di percorrere nuove strade capaci di stupire nel momento giusto.
Un gesto semplice per ribaltare una comoda seduta in funzionale piano d'appoggio.

Contemporary man with the desire to travel new roads able to surprise at just the right moment. a simple act to turn a comfortable pouff into a functional support base.









L'identità di Silver asseconda la sua anima versatile e ne valorizza la relazione con il luogo grazie alla possibilità di scegliere il colore del piano del tavolino.

Silver's identity supports its versatile soul and enhances its relationship with the room thanks to the possibility of choosing the color of the table top.

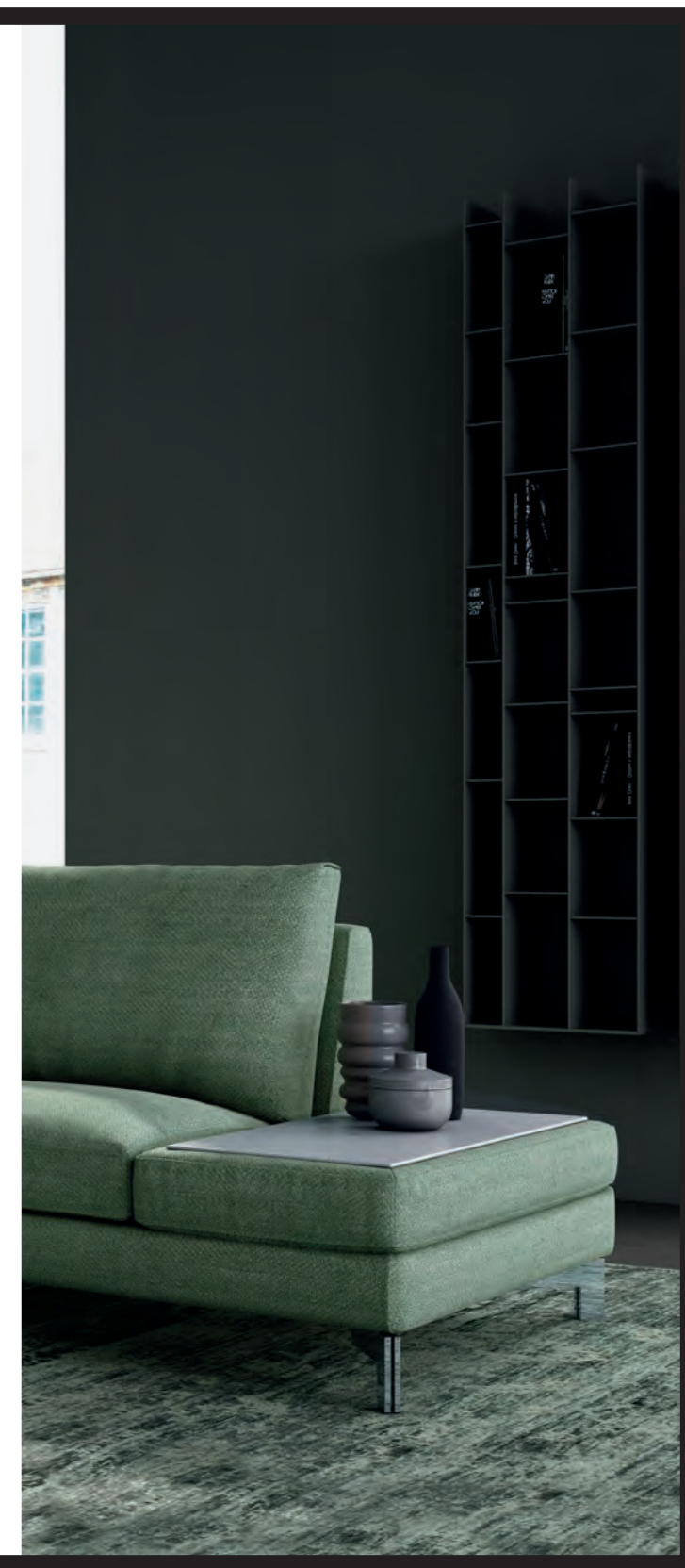

TAG

Ispirazione dal passato e desiderio di unicità per Tag. Una poltrona dall'aspetto formale seducente e rigoroso nello stesso tempo. La creatività trova espressione nell'uso consapevole di materiali diversi, capaci di definire una precisa identità.

Inspiration from the past and uniqueness' desire for Tag. An armchair with a charming and rigorous formal aspect at the same time. Creativity finds expression in the conscious use of different materials, capable of defining a clear identity.



NICK

Energia e carattere. Un progetto capace di valorizzare la relazione del prodotto con l'ambiente. Nick è l'espressione della connessione tra comfort e design in sintonia con le esigenze della quotidianità contemporanea.

Energy and personality. A project capable of enhancing the relationship of the product with the space. Nick is the expression of the connection between comfort and design, in harmony with the contemporary everyday life's need.











NOAH

Zona notte o zona giorno? Design razionale ed estetica confortevole per la chaise longue che diventa protagonista in ogni ambiente. La scelta del rivestimento e l'abbinamento cromatico con i cuscini gioca un ruolo importante nel determinarne il carattere.

Bedroom or living room? Rational design and comfortable aesthetics for the chaise longue which becomes protagonist in any space. Upholstery's choice and chromatic combination with the cushions play an important role in determining its character.



BELLO

Infinite possibilità di combinazioni capaci di emozionare per un progetto personale capace di esprimere la voglia di cambiamento e di versatilità.

Infinite exciting combination possibilities for a personal style that expresses the desire for change and versatility.









DEFINIRE IL TUO NUOVO
STILE È SEMPLICE: PUOI
SCEGLIERE SCHIENALI DI
MISURE UGUALI OPPURE
DIVERSE, COLORI TONO
SU TONO OPPURE A
CONTRASTO.
ACCOSTARE VOLUMI
DIVENTA UN GIOCO
E DEFINISCE
NUOVE FORME.

*Designate your new style is simple: You can
choose backs of equal or different sizes, tone-
on-tone or contrasting colors. Put volumes
near each other becomes a game and defines
new shapes.*







FROG

Eleganza poetica ed ergonomia accogliente sono le caratteristiche che definiscono il carattere forte di Frog. Il progetto nel segno della ricerca estetica e della funzionalità, trova il suo completamento nell'accostamento del pouff alla poltrona.

Poetic elegance and comfortable ergonomics are the characteristics which define Frog's strong personality. In the name of aesthetic research and functionality, this project finds its completely in the combination of the pouf with the armchair.





LINK

L'armonia si costruisce nel design e si definisce nei dettagli...e tutto diventa un gioco: scegliere la chaise longue oppure l'angolo conversazione; la cucitura tono su tono oppure con filo a contrasto; la forma e i volumi dei cuscini più glamour.

Harmony is in the design and defined in the details ... and everything becomes a game: choose the chaise longue or the conversation corner; tone on tone stitching or with contrasting thread; the most glamorous cushion shapes and volumes.







FINALMENTE IL FILO DI
UN NUOVO RACCONTO DA
VIVERE NEI TONI CHE CI
APPARTENGONO DAVVERO.
GLI ABBINAMENTI DEI
COLORI SI ESPRIMONO
SENZA CONVENZIONI:
CONTRASTO OPPURE
TONO SU TONO?

*Stitching finally the thread of a new story to
experience in shades that truly belong to us.
colour combinations express themselves
without conventions: contrast or tone on tone?*



BON TON



Armonia ed equilibrio determinano la bellezza nell'architettura geometrica dei pouf, il comfort delle ampie sedute e la cucitura decorativa completano ed arricchiscono il design elegante.

Harmony and Balance define the geometrical beauty of these poufs, comfort of wide seat and the decorative seam complete and enrich the elegant design.



BON BON



Piedini sottili ed originali sostengono la seduta imbottita determinandone la forte personalità. Bon Bon ha un design essenziale, ma molteplici identità. E' divertente ed elegante nello stesso momento, capace così di integrarsi in ogni ambiente.

Thin and original feet support the padded seat defining its strong personality. Bon Bon has an essential design, but several identity. It is fun and elegant at the same time, capable to integrate in any space.



DISCOVERY

Il concetto di spazio è in continuo cambiamento e gli oggetti mutano la loro funzione in modo rapido e originale. Discovery è un elemento che vive in modo trasversale, assecondando l'esigenza del quotidiano.

The concept of space is constantly developing and the objects change their function quickly and originally. Discovery is an element that lives in a crossing way, supporting the need of everyday life.

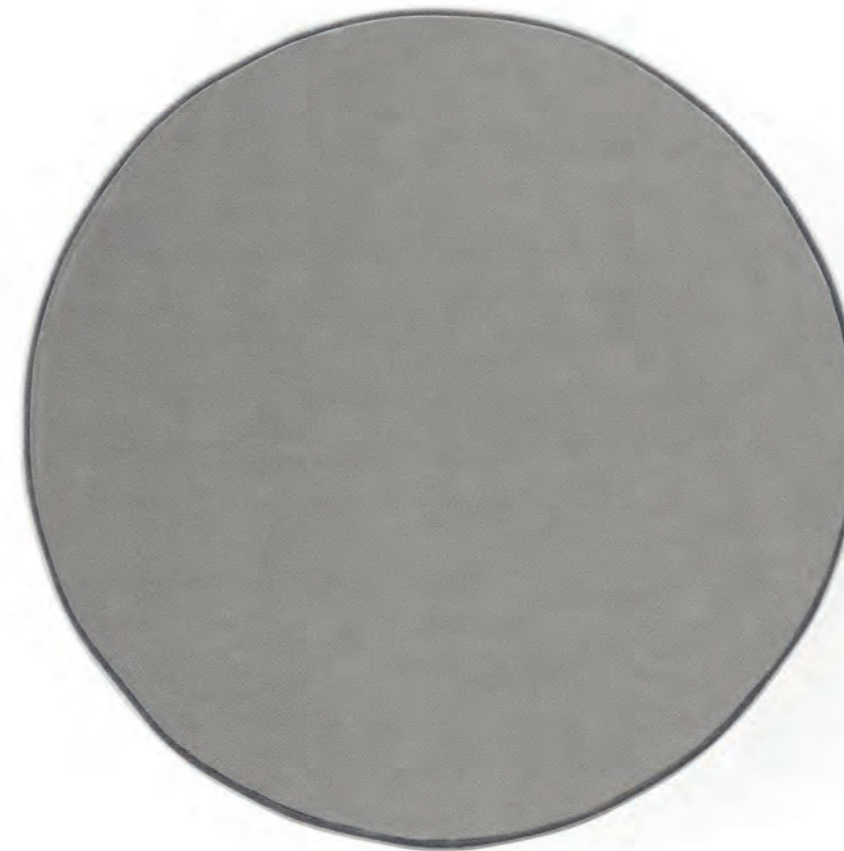

POUFF

Il pouff anima l'ambiente con colori e forme diverse: da solo oppure accostato ai divani, diventa un elemento d'arredo capace di creare atmosfere inaspettate in spazi sofisticati, contemporanei e classici.

The pouff brings the space to life with different colors and shapes: on its own or combined with sofas, it becomes a furnishing element capable of creating unexpected atmospheres in sophisticated, contemporary and classic living.



— PUFFOLINE

PUFFOLINE —

— PUFFO

JOY

Joy regala l'occasione di interpretare lo spazio e asseconda la moderna ricerca di ambiente dinamico, attraverso un progetto capace di esaltare il valore estetico e funzionale di ogni singolo pezzo. Volumi importanti e ampia profondità di seduta con molteplici possibilità di componibilità in grado di suggerire una scelta senza compromessi.

The aesthetical value and functionality of each element give you the possibility of interpreting the space around you, favouring modern search for dynamic rooms. Important dimensions and deep seats, a wide choice of elements which can be combined together allow various compositions without compromise.







Ampi spazi di seduta e componibilità estremamente versatile per creare una dimensione nuova, un luogo dove mettere in ordine i pensieri, progettare nuove esperienze e condividere una nuova estetica funzionale e rilassante.

Plenty of seating space and extremely versatile modules create a new dimension, a place to collect your thoughts, plan new experiences and share the pleasure of practical, comfortable good looks.



ALEX

Ampie ma leggere sedute, quasi sospese su agili piedini in metallo che fanno da cornice alle linee avvolgenti della struttura che accoglie come un "guscio" morbidi ed invitanti cuscini. Questi sono dettagli creativi di un'estetica che trova nell'essenzialità la sua massima espressione.



Wide but light seats as they were flying over the slender metal legs, which together with metal frame enclose, as a shell does, soft and inviting cushions. Creative details, pure aesthetics, that come out from essentiality.





ZENO

Il desiderio di unicità è sempre forte e cresce con l'intento di soddisfare sogni ed ambizioni. Nel design si traduce in una nuova ricerca stilistica mirata ad interpretare in modo originale e con massima libertà spazio e volume.

The desire for uniqueness is ever stronger and grows with the intention of satisfying dreams and ambitions. In design it translates into researching new styles aimed at interpreting space and volume in original ways and with the greatest freedom.









MAX

Rigore e serietà si trasformano in accogliente e morbido senso di comfort. I dettagli della geometria, la scelta del piede e il suo abbinamento cromatico con il rivestimento valorizzano il rapporto di Max con il contesto del luogo.

Strictness and seriousness are transformed into a welcoming and soft sense of comfort. The geometry's details, the choice of the foot and its chromatic combination with the upholstery enhance Max's relationship with the context of the place.





AVATAR

Equilibrio ed armonia per creare un modello che fa parlare di sè. Le finiture di cuscini e sedute e gli eleganti profili in acciaio dei piedi definiscono un progetto con una forte identità contemporanea.

Balance and harmony creating a model that makes people talk about itself. The finishes of the cushions and seats and the elegant steel profiles of the feet define a project with a strong contemporary personality.



AVATAR È UN PROGETTO
DA VEDERE, DA TOCCARE
E SOPRATTUTTO DA VIVERE.
È LA RISPOSTA
ALL'EVOLUZIONE DEI
MODI DI ABITARE.

*Avatar is a project to see, to touch and above
all to live. It is the answer to the ways-of-living
evolution.*



PLAY

Una dote dinamica che conduce a ciò che per Biba è un punto fermo: il comfort. Le chance di componibilità si moltiplicano, così come la libertà di godersi ogni singolo particolare. Il bracciolo è disponibile nella misura 26 cm e nella versione Play Light, 20 cm.

The wide choice of modular units increases as the possibility of enjoying each detail. A dynamic characteristic that recalls one of Biba's main points comfort. The armrest is available in size 26 cm and in size 20 cm in the Play Light version.



PLAY



PLAYLIGHT







PLAY

ARMCHAIR



MASTER

Design dinamico, linee rigorose, volumi invitanti, Master è capace di proporsi con un'estetica equilibrata per divenire sicuro protagonista di ogni ambiente.

Thanks to its dynamic design, rigorous lines and inviting shapes, Master embodies a balanced sense of aesthetics, immediately becoming the main protagonist in every room.







Con un semplice gesto possiamo godere del massimo comfort. L'avanzamento della seduta e il ribaltamento del poggiatesta favoriscono la conquista di una posizione completamente dedicata al relax.

With a simple movement you can enjoy maximum comfort. By moving forward seat cushions and lifting up headrests you gain additional space for your complete relaxation.



BOSTON

Boston si presenta semplicemente confortevole e diventa la risposta alla nostra incontrollabile voglia di cambiamento.

Boston is simply comfortable. It becomes the answer to our exquisite need of changes.





IL DESIGN RAZIONALE
EVIDENZIA GLI AMPI
VOLUMI E LA DINAMICA
DEL MOVIMENTO DELLO
SCHIENALE. BOSTON È
CAPACE DI INTERPRETARE
LO SPAZIO SEGUENDO
LE ESIGENZE SEMPRE
DIVERSE CHE SCOPRIAMO
NEL VIVERE QUOTIDIANO.

Rational design highlights spacious seats and dynamism of backrest movement. It's able to follow the different space needs that we discover in everyday life.



CHARLIE

La possibilità di godersi il proprio spazio in libertà diventa un sogno realizzato con Charlie. Lineare eppure originale, semplice ma unico. L'armonia dinamica è il suo vero punto di forza.

The chance to freely enjoy your own space becomes a dream come true with Charlie. Linear yet original, simple yet unique. Dynamic harmony is its true strong point.









BRAD

E' bello trovare conferma dei propri desideri in spazi reali, dove vivere in relax il vivere quotidiano. Il sofa evita il puro narcisismo a favore di un design funzionale e di una forte identità personale.

It's good to find your desires met in real spaces where you can relax and enjoy the pursuits of everyday living. The sofa avoids pure narcissism in favour of a practical design and a strong personal identity.









ADELAIDE

La stessa anima è capace di disegnare due storie diverse per carattere e attitudine: contemporanea e sofisticata.

The same soul tells two stories with different personalities and attitudes: contemporary and sophisticated.



PLANO

Sentirsi unici è un'esigenza comune, occorre riuscire ad immaginare nuovi scenari dinamici e ricercati: il ritmo delle cuciture diventa così il dettaglio che rende originale il total white.

Feeling unique is a common need, you have to be able to imagine new, dynamic scenarios: so the rhythm of the stitching becomes the detail that makes total white original.





LO SPAZIO CHE ABITI
OGGI PARLA DI TE
CON TONI CHE
PUOI SCEGLIERE.
OGNI COLORE
RACCONTA UNA STORIA.

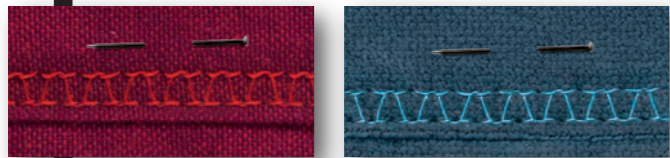

*Your living space today speaks about you
with the tones you can choose. Each color
tells a story.*



ALTEA

Forme che hanno una storia da raccontare, capaci di dare una nuova interpretazione di un luogo e diventare protagonista di una storia esclusiva e quotidiana: il design si esprime con originalità.

Severe and rigorous as they may look at glance, armchairs Max actually give you a cozy and soft sensation as they wrap around you with the deep seat, expression of studied philosophy of geometrical relaxation.











CLORINNE



WILLY



PIUMA

Un'estetica di design non invadente, discreta e accogliente, dove morbidi cuscini lievemente appoggiati alla struttura predispongono l'animo a vivere al meglio i movimenti di relax.

Discreet, welcoming design of soft cushions placed over the sofa's structure invite you to reach complete relaxation.





RALPH

Per diventare grandi a volte è necessario uno sguardo al passato, e così le nuove generazioni hanno bisogno con rinnovata consapevolezza della competenza dei maestri, capaci di unire sapere e mestiere in accostamenti unici ed originali.

To become great it's sometimes necessary to look at the past, and new generations need renewed awareness of the skill of masters able to unite know-how and craftsmanship in unique and original combinations.





EGO

SOFA - BED

Design dinamico, linee rigorose, volumi invitanti, Ego è capace di proporsi con un'estetica equilibrata per divenire sicuro protagonista di spazi destinati al relax quotidiano.

Dynamic design, rigorous lines and attractive shapes . Ego's balanced aesthetics becomes the main protagonist of the space for your everyday comfort.







AGADIR

SOFA-BED

Assoluto comfort di seduta. Linee raffinate e semplici per un protagonista trasformista: con un gesto la seduta diventa un vero letto matrimoniale. Agadir è la risposta alle esigenze del vivere contemporaneo.

Absolute sitting comfort. Refined and simple lines for a quick-change protagonist: with just one movement, the seat becomes a real double bed. Agadir is the answer to the requirements of contemporary living.





AIRON

SOFA - BED

Airon e' capace di mostrarsi glamour ed aristocratico al tempo stesso. Le sue forme sinuose e il design ricercato ne sottolineano i punti di forza, rendendolo pura espressione di accoglienza di giorno e nido di estremo comfort di notte.

Airon appears to be glamour and aristocratic at the same time. Sinuous shapes and refined design are the Airon's best characteristics that make the sofa pure expression of hospitality during the day and nest of comfort at night.





HOLÀ

SOFA - BED

Holà si mostra subito un divano dal carattere moderno e armonioso, capace di svelare all'occorrenza un'anima comoda e rilassante grazie a un materasso ortopedico a molle h. 15 cm.

Hola' at a glance a sofa with a modern character when needed, it reveals its comfortable and relaxing soul, thanks to its orthopaedic mattress with springs 15 cm h.



SURF

SOFA-BED



Design dinamico, linee rigorose, Surf è capace di proporsi con un'estetica equilibrata per divenire sicuro protagonista di ogni ambiente.

Thanks to its dynamic design, rigorous lines and inviting shapes Surf embodies a balanced sense of aesthetics, surely becoming main protagonist in every environment.



SETTE

SOFA - BED



La geometrica sobrietà della linea cela il segreto di un letto comodo come il divano che lo custodisce, dalla personalità estremamente confortevole perché avvalorata da un'imbottitura di grande pregio.

The geometric sobriety of its lines conceals the secrets of a bed, as much comfortable as the sofa in which it is contained, an extremely comfortable personality made of paddings of great quality.



OTTO

SOFA - BED



Romanticismo, eleganza e calore delineano la sua chiara identità classica, che non rinuncia alla seduzione di linee morbide ed accoglienti, garantendo un comfort intenso come i momenti che è destinato a vivere.



Romanticism, elegance and warmth outline its classic identity without denying the seduction of soft and cozy lines that guarantee an intense comfort for the precious moments of your life.



DIECI

SOFA - BED



Con un semplice gesto possiamo godere del massimo comfort. Dieci svela un'anima comoda e rilassante grazie a un materasso ortopedico a molle di cm 15.

With a simply movement you can enjoy maximum comfort. Dieci reveals its comfortable and relaxing soul, thanks to its orthopaedic mattress with springs 15cm h.



MADISON

SOFA - BED

Un meccanismo sofisticato ed una stessa scocca base sono "l'anima" di Madison tipo 4,3,2 e 1. Anima che prende forma in quattro differenti modelli di compiuta armonia ed equilibrato design e offre spazio ad un comodo materasso ortopedico a molle di cm 15. Braccioli e piedini variamente abbinati sono dettagli determinanti che sanciscono la definizione estetica del Madison: attuale, classico, generoso o sinuoso.

A sophisticated mechanism and the same frame are the "heart" of Madison 4,3,2, and 1. A heart taking shape in four different models of perfect harmony and well-balanced design, offering storage for pillows and a orthopaedic mattress of cm 15. Armrests and feet to be combined at choice become determining details that enforce the Madison's aesthetics: up-to-date, classic, generous or sinuous.



TIP01/TYP1



TIP02/TYP2



TIP03/TYP3



TIP04/TYP4



NINNA

ARMCHAIR-BED



NANNA

POUFF-BED



MATERIALI

MATERIALS



LEGNO

IL MATERIALE PIÙ PREZIOSO



Biba Salotti sceglie per la realizzazione dei prodotti della propria azienda, legno di alta qualità nella consapevolezza del valore assoluto di questo materiale prezioso, impegnandosi a razionalizzarne l'utilizzo durante il ciclo produttivo ed avvalendosi di collaboratori che verificano la provenienza del legno da foreste sottoposte a opere di disboscamento controllato in modo da non compromettere il patrimonio forestale.

I legni impiegati per la costruzione delle parti strutturali portanti sono di multistrato di pioppo, per le parti di chiusura utilizziamo legno compensato e faesite. Per le parti a vista come piedi o mobiletti di complemento utilizziamo legni nobili quale faggio, wenghè, rovere o ciliegio. La pluriennale esperienza artigianale e la conoscenza delle moderne tecnologie permettono la realizzazione di strutture decisamente solide, ottime basi di partenza per la costruzione di un soggetto imbottito confortevole ed ergonomico.

Wood, the most valuable material. *Biba Salotti chooses wood of the highest quality in accordance with its value. Our aim is to optimize its consumption during production cycle and we use wood taking care it comes from controlled deforestation area, in order to protect our forest heritage. Wood used for structural parts is of multilayer poplar, while for the closing parts is of plywood and hardboards. All visible parts, such as feet or design components are of noble woods such as beech, wenge, oak or cherry. The long lasting experience of handmade working and knowledge of the most up-to-date technologies allow the realization of surely strong structures that is a perfect starting point for the setting of a comfortable and ergonomic upholstered sofa.*



RELAX

L'EQUILIBRIO DELL'ANIMA



Gli imbottiti Biba Salotti sono realizzati con materiali naturali ed innovativi selezionati secondo i più rigorosi criteri di qualità, sicurezza e solidità. Queste caratteristiche e la cura artigianale dei dettagli costruttivi determinano il pregio e la durata nel tempo di ogni prodotto. Nelle nostre progettazioni viene privilegiata la ricerca del relax, equilibrio dell'anima.

La struttura dei nostri imbottiti viene ricoperta da materiali a diversa densità, selezionati a seconda della posizione in cui vengono impiegati valutando le necessità della nostra spina dorsale al fine di non costringerla in posizioni scorrette in modo da non danneggiare muscoli articolazioni e legamenti. Il sistema di molle all'interno dei cuscini di seduta assicurano la massima comodità essendo comunque protette da una stratificazione, che le rende impercettibili pur garantendo la resistenza nel tempo.

La comoda accoglienza dei nostri cuscini e la sensazione di comfort è determinata dal giusto ed equilibrato dosaggio tra piume d'oca e d'anatra (prodotto accuratamente lavato, sterilizzato ed anallergico) che avvolgono un'anima di poliuretano a spessore differenziato; il tutto racchiuso in una candida fodera di puro cotone.

Comfort, soul balance. *Biba Salotti sofas are made of natural and innovative materials selected by manufacturer according to criteria of quality, safety and solidity. Such characteristics combined with accuracy of traditional working methods make each Biba's sofa precious and durable. We favour research of relax, balance of soul in all our design. Wood structure of our upholstered sofa is covered by materials with different density to grant correct and healthy backbone sitting without damaging articulations, muscles and ligaments. The springs' system located inside seat cushions is covered by a thick protection layer which grant their durability and comfort of seating. The filling of our backrest's cushions comes from a correct and balanced ratio between goose and duck downs (carefully washed, sterilized and hypoallergenic) with a polyurethane foam of different thicknesses. All our cushions are finally covered by a white cloth made of pure cotton.*



I DETTAGLI

LA NOSTRA FORZA

I dettagli sono il punto di forza della nostra produzione, in particolare il sistema antiscivolo è stato studiato per garantire al cuscino di seduta stabilità e ordine.

Le cuciture rappresentano un passaggio fondamentale, concettualmente semplici, in realtà esse si declinano in una miriade di variabili, cambiate a seconda della posizione in cui intervengono. A livello estetico esse rappresentano un elemento di ricercatezza.

La lavorazione applicata alla produzione dei nostri modelli si ispira a criteri artigianali, così come un tempo, ancora oggi i tessuti utilizzati per il confezionamento vengono cuciti seguendo un procedimento antico indispensabile per salvaguardare il manufatto da imperfezioni.

Details, our strength. *Details are our strength, in particular our system of skid stopping, which ensures stability and order of cushions. Seams are basic even though very simple. In reality they are so numerous and versatile according to their different settings. They represent a refinement object at aesthetic level. Production cycle of our models is ruled by criteria of handmade working, the same of many years ago. Today we use fabrics which are sewn following an ancient process, so important in order to safeguard our products from defects.*



TESSUTI

ESPRESSIONE DI QUALITÀ

Biba Salotti è consapevole della necessità di offrire alla clientela più esigente la possibilità di scegliere il rivestimento in una vastissima collezione di tessuti. Ogni modello diventa così una nuova interpretazione attraverso la selezione di colori accesi, fibre e toni naturali, o tessuti tech e colori di tendenza. L'azienda si impegna con professionalità a studiare la compatibilità tra le caratteristiche del rivestimento e le peculiarità tecniche ed estetiche del soggetto da rivestire.

Ogni materiale presente in collezione è stato sottoposto a test che ne individuano e garantiscono le caratteristiche di qualità, resistenza e durata alle abrasioni. Ogni articolo venduto viene accompagnato da una scheda tecnica riguardante il tessuto utilizzato per la realizzazione del divano, nella quale vengono riportate le norme specifiche per la manutenzione e la composizione del tessuto.

Fabrics, quality expression. *Biba salotti knows very well that it is necessary to offer its customers a wide range of fabrics to choose for their sofas' covering.*

In this way, every model becomes a unique piece, according to the selection of bright colours, natural fibres and shades, or high tech fabrics and fashion colours.

Bibasalotti studies carefully the characteristics of covering in accordance with technical and aesthetic features of the sofa.

Every material of our collection has been tested to guarantee high quality, resistance and abrasion resistance. Our sofa is sold with a technical datasheet containing details of the used fabric and its composition and specific maintenance instructions.



SCHEDE TECNICHE

TECHNICAL FEATURES



AGADIR

Pagina 214

Design:
Studio Archimeta



S O F A - B E D



La profondità del divano con la rete aperta é di cm 217.

The depth of the sofa when the bed is open is 217 cm.

STRUTTURA

Struttura in legno e multistrato imbottita in poliuretano a quote differenziate e rivestita in resinato accoppiato dello spessore di 10 mm.

TELAIO

Telaio sotto i cuscini di seduta in multistrato per le versioni fisse.

SEDUTA - versione fissa

Cuscini di seduta in poliuretano densità minima 30 HR, con inserti centrali in molle, il tutto rivestito da una falda Dacron.

SEDUTA - versione letto

Cuscini di seduta in poliuretano densità minima 30 HR rivestiti da una falda Dacron.

SCHIENALE - per versioni letto e fisse

Cuscini schienale 100% in piuma naturale depolverizzata, lavata e sterilizzata, a camere separate orizzontalmente, con inserto in poliuretano interamente rivestiti da una tela in cotone 100%.

GUANCIALI

Guanciali 100% piuma naturale lavata, depolverizzata e sterilizzata. Misura dei guanciali 50 X 50 cm con fascette.

RETE E MATERASSO

Rete a maglia elettrosaldata con materasso a molle H 15 cm.

STRUCTURE

Laminated wood structure padded with polyurethane foam of different densities and covered in a 10 mm layer of bonded resin.

FRAME

Fixed versions are equipped with a plywood frame supporting the seat cushions.

SEAT - fixed Version

Polyurethane padding seat cushions with a minimum density of 30 HR with central spring inserts, covered in a layer of Dacron.

SEAT - bed version

Polyurethane padding seat cushions with a minimum density of 30 HR covered in a layer of Dacron.

BACKREST- for both bed and fixed versions

Backrest cushions 100% natural dust-free, washed and sterilized down padding arranged in separate horizontal chambers with a polyurethane insert and 100% cotton fabric cover.

PILLOW

100% natural dust-free, washed and sterilized down Pillows. Pillow size 50 X 50 cm including Bands.

BED BASE AND MATTRESS – bed version

Electrowelded wire mesh bed base with a 15 cm spring mattress.

DIVANO / SOFA

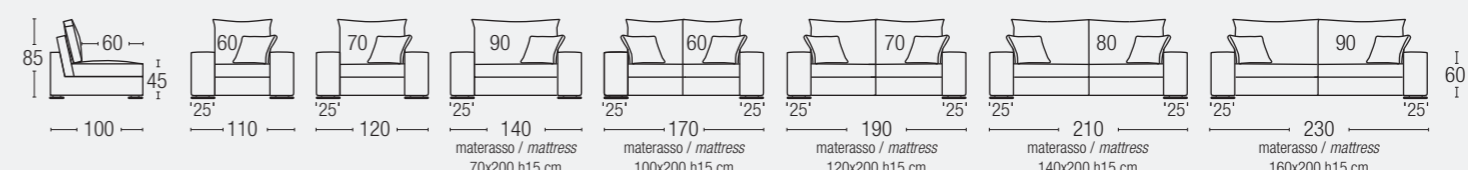

TERMINALE / ARMREST UNIT

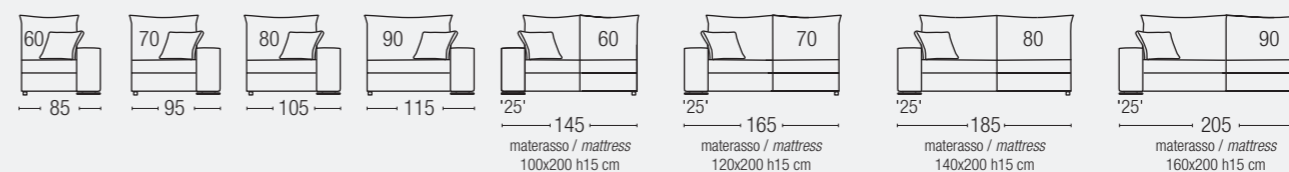

ANGOLO / CORNER



ANGOLARE CON POUF / CORNER WITH POUF



POUF



PIEDINI / FOOT

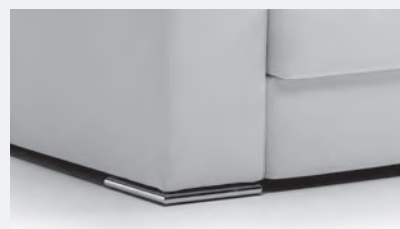

ANGOLARE / ANGULAR FOOT

Cromato lucido / Polished chromed angular foot
h. 4 cm

AIRON

Pagina 218

Design:
Studio Archimeta



S O F A - B E D



La profondità del divano con la rete aperta é di cm 218.

The depth of the sofa when the bed is open is 218 cm.

STRUTTURA

Struttura in legno e multistrato imbottita in poliuretano a quote differenziate e rivestita in resinato accoppiato dello spessore di 10 mm.

TELAIO

Telaio sotto i cuscini di seduta in multistrato per le versioni fisse.

SEDUTA - sia versione letto che fissa

Cuscini di seduta 100% in piuma naturale depolverizzata, lavata e sterilizzata a camere separate orizzontalmente e supportati da un inserto in poliuretano.

SCHIENALE - sia versione letto che fissa

Cuscini schienale 100% in piuma naturale depolverizzata, lavata e sterilizzata, a camere separate orizzontalmente, con inserto in poliuretano interamente rivestiti da una tela in cotone 100%.

RETE E MATERASSO - versione letto

Rete a maglia elettrosaldada con materasso a molle altezza 15 cm.

PIEDE

Per entrambe le versioni H 4 cm.

STRUCTURE

Laminated wood structure padded with polyurethane foam of different densities and covered in a 10 mm layer of bonded resin.

FRAME

Fixed versions are equipped with a plywood frame supporting the seat cushions.

SEAT- for both bed and fixed versions

Seat cushions made of 100% natural dust-free, washed and sterilized down padding arranged in separate horizontal chambers supported by a polyurethane insert.

BACKREST- for both bed and fixed versions

Backrest cushions 100% natural dust-free, washed and sterilized down padding arranged in separate horizontal chambers with a polyurethane insert and 100% cotton fabric cover.

BED BASE AND MATTRESS – bed version

Electrowelded wire mesh bed base with a 15 cm spring mattress.

FOOT

For both versions (bed and fixed) H 4 cm.

DIVANO / SOFA

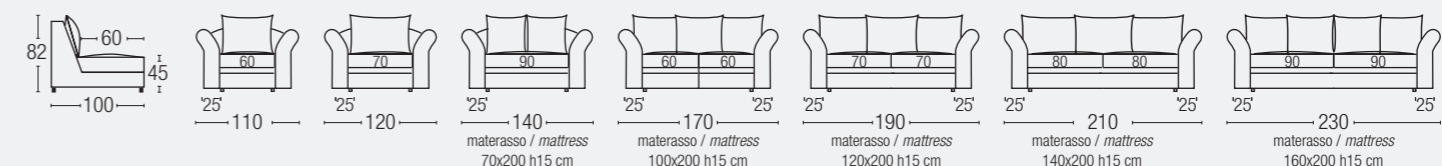

POUF

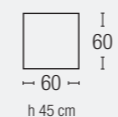

PIEDINI / FOOT



Per entrambe le versioni (sia letto che fissa)
/ For both versions (bed and fixed)
h. 4 cm



ALEX

Pagina 124

Design:
Danilo Bonfanti

STRUTTURA

Struttura in legno e multistrato imbottita in poliuretano a quote differenziate e rivestita in resinato accoppiato dello spessore di 10 mm.

TELAIO

Telaio sotto i cuscini di seduta in multistrato.

SEDUTA

Cuscini di seduta in poliuretano densità minima 30 HR, con inserti centrali in molle, il tutto rivestito da una falda Dacron.

SCHIENALE

Cuscini schienale 100% in piuma naturale depolverizzata, lavata e sterilizzata, a camere separate orizzontalmente, con inserto in poliuretano interamente rivestiti da una tela in cotone 100%.

CUSCINI BRACCIOLI

Cuscini bracciolo 100% in piuma naturale depolverizzata, lavata e sterilizzata, a camere separate orizzontalmente

STRUCTURE

Laminated wood structure padded with polyurethane foam of different densities and covered in a 10 mm layer of bonded resin.

FRAME

Plywood frame supporting the seat cushions.

SEAT

Polyurethane padding seat cushions with a minimum density of 30 HR with central spring inserts, covered in a layer of Dacron.

BACKREST

Backrest cushions 100% natural dust-free, washed and sterilized down padding arranged in separate horizontal chambers with a polyurethane insert and 100% cotton fabric cover.

ARMREST CUSHIONS

Armrest cushions have a 100% natural feather filling arranged in separate horizontal chambers.

DIVANO / SOFA

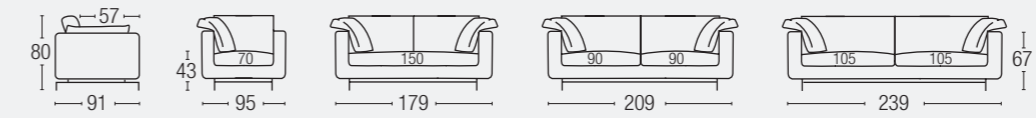

sporgenza cuscino bracciolo 5 cm cad./
increased by 5 cm for each cushions

POUF

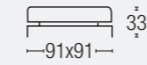

PIEDINI / FOOT



PONTE/ PONTE FOOT

Cromato / Chromed
h. 17 cm



ALTEA

Pagina 188

Design:
Danilo Bonfanti

S O F A - B E D



La profondità del divano con la rete aperta è di cm 250.

The depth of the sofa when the bed is open is 250 cm.

STRUTTURA

Struttura in legno e multistrato imbottita in poliuretano a quote differenziate e rivestita in resinato accoppiato dello spessore di 10 mm

MOLLEGGIO - versione fissa

Molleggio della seduta in nastri elastici intrecciati ad alta densità

SEDUTA - sia versione fissa che letto

Cuscini di seduta 100% in piuma naturale depolverizzata, lavata e sterilizzata a camere separate orizzontalmente interamente rivestiti da una tela in cotone 100% supportati da una base in poliuretano.

SCHIENALE - sia versione fissa che letto

Cuscini schienale 50% in piuma naturale depolverizzata, lavata e sterilizzata - 50% poliuretano, a camere separate orizzontalmente interamente rivestiti da una tela in cotone 100%.

GUANCIALI

Guanciali 100% piuma naturale, lavata, depolverizzata e sterilizzata. Misure dei guanciali diverse a seconda della composizione.

RETE E MATERASSO - versione letto

Rete a doghe in legno di faggio con materasso altezza 8 cm in poliuretano densità 30 HR.

STRUCTURE

Laminated wood structure padded with polyurethane foam of different densities and covered in a 10 mm layer of bonded resin.

SUSPENSION - fixed version

The seat suspension system uses high-density intertwined elastic bands.

SEAT- for both fixed and bed versions

Seat cushions made of 100% natural dust-free, washed and sterilized down padding arranged in separate horizontal chambers supported by a polyurethane base.

BACKREST

Backrest cushions 50% natural dust-free, washed and sterilized Down padding – 50% Polyurethane arranged in separate horizontal chambers, 100% cotton fabric cover.

PILLOW

100% natural dust-free, washed and sterilized down Pillows. The pillow sizes vary based on sofa composition.

BED BASE AND MATTRESS – bed version

Bed Base made of beechwood slats with a 8 cm, 30 HR density Polyurethane mattress.

DIVANO / SOFA

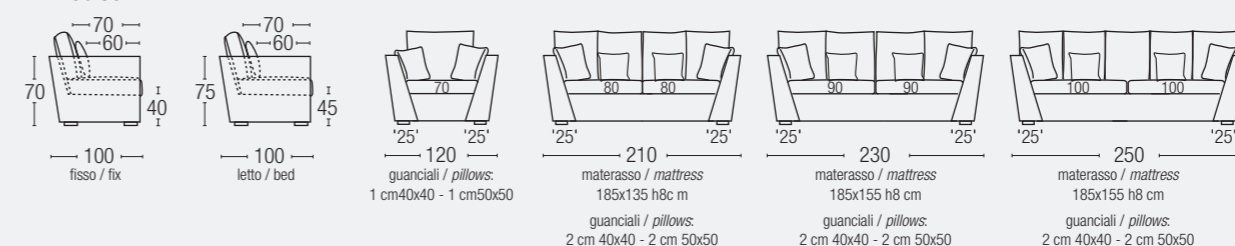

TERMINALE / ARMREST UNIT

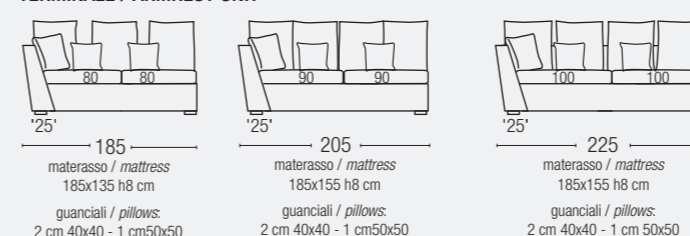

ANGOLO / CORNER

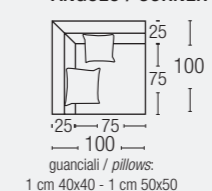

TERMINALI CURVI / CURVED ARMREST UNIT

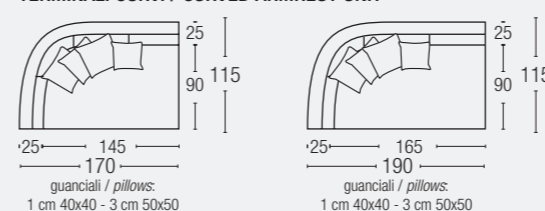

PANCA / BENCH

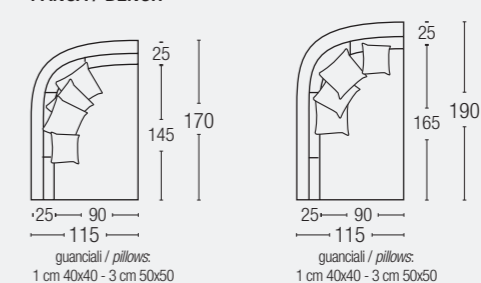

PIEDINI

Versione fissa
FOOT
Fixed version



PIEDE A SCOMPARSA /RETRACTABLE FOOT

in legno, a forma cilindrica, in tinta wengé H 3 cm / *Wengé coloured, cylindrical wood foot H 3 cm*

PIEDINI

Versione letto
FOOT
Bed version



NAVE / NAVE FOOT

Cromato / *Chromed*
h. 8 cm
SOLO VERSIONE LETTO
ONLY BED VERSION



AVATAR

Pagina 140

Design:
Studio Archimeta

STRUTTURA

Struttura in legno e multistrato imbottita in poliuretano a quote differenziate e rivestita in resinato accoppiato dello spessore di 10 mm.

TELAIO

Telaio sotto i cuscini di seduta in multistrato.

SEDUTA

Cuscini di seduta in poliuretano densità minima 30 HR, con inserti centrali in molle, il tutto rivestito da una falda Dacron.

SCHIENALE

Cuscini schienale 50% in piuma naturale depolverizzata, lavata e sterilizzata - 50% poliuretano, a camere separate orizzontalmente interamente rivestiti da una tela in cotone 100%.

GUANCIALI

Guanciali 100% piuma naturale lavata, depolverizzata e sterilizzata. Misura dei guanciali 50 X 50 cm.

STRUCTURE

Laminated wood structure padded with polyurethane foam of different densities and covered in a 10 mm layer of bonded resin.

FRAME

Plywood frame supporting the seat cushions.

SEAT

Polyurethane padding seat cushions with a minimum density of 30 HR with central spring inserts, covered in a layer of Dacron.

BACKREST

Backrest cushions 50% natural dust-free, washed and sterilized Down padding - 50% Polyurethane arranged in separate horizontal chambers, 100% cotton fabric cover.

PILLOW

100% natural dust-free, washed and sterilized down Pillows. Pillow size 50 X 50 cm.

DIVANO / SOFA

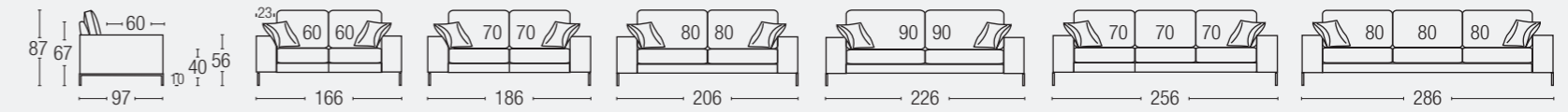

TERMINALE / ARMREST UNIT

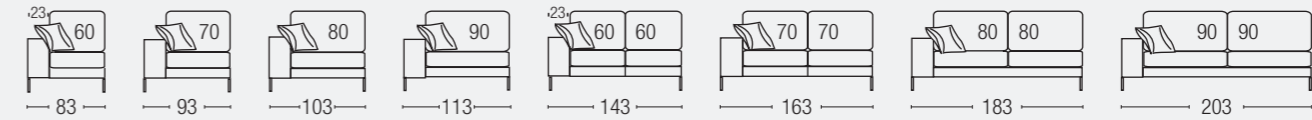

POUF



PANCA / BENCH



CHAISE LONGUE

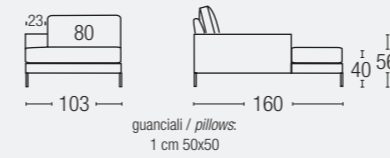

PENISOLA / PENINSULA

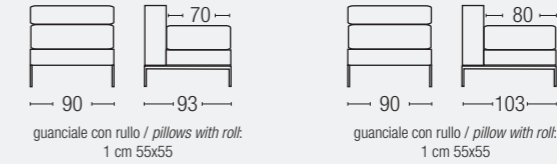

ANGOLO / CORNER

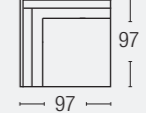

PIEDINI / FOOT



PONTE / PONTE FOOT

Cromato lucido / Polished chromed
h. 10 cm



BELLO

Pagina 084

STRUTTURA

Struttura in legno e multistrato imbottita in poliuretano a quote differenziate e rivestita in resinato accoppiato dello spessore di 10 mm.

MOLLEGGIO

Molleggio della seduta in nastri elastici intrecciati ad alta densità.

SEDUTA E SCHIENALE con peso

In poliuretano densità minima 30 HR rivestiti da una falda Dacron.

CUSCINI

Cuscini schienale cm 60x60: 50% in piuma naturale depolverizzata, lavata e sterilizzata - 50% cin fill ball (fibra poliestere siliconata cava a pallino).

STRUCTURE

Laminated wood structure padded with polyurethane foam of different densities and covered in a 10 mm layer of bonded resin.

SUSPENSION

The seat suspension system uses high-density intertwined elastic bands.

SEAT AND BACKREST with weight

Polyurethane padding with a minimum density of 30 HR covered in a layer of Dacron.

BACKREST AND ARMREST

Backrest cushions 60x60cm: 50% natural dust-free, washed and sterilized Down padding - 50% Cin Fill Ball (silicone-coated hollow polyester fibre pellets).

PIEDINI ALTO/ HIGH FOOT



PONTE NICK / PONTE NICK FOOT

Brunito / Burnished
Cromato lucido / Polished chromed
Satinato / Satin
h. 15 cm
A richiesta / On request:
- Montaggio a 45°/45° angle installation
- RAL verniciato opaco / Matt RAL varnished



SPILLO NICK / SPILLO NICK FOOT

Brunito / Burnished
Cromato lucido / Polished chromed
Satinato / Satin
h. 15 cm
A richiesta / On request:
- RAL verniciato opaco / Matt RAL varnished

PIEDINI BASSO / LOW FOOT



SCOMPARSA / RETRACTABLE FOOT

a scomparsa in legno cilindrico in tinta Wengé
Wengé coloured cylindrical wood foot
h. 4 cm

BREAK TAVOLINI / COFFEE



TONDO / ROUND
Ø 40 cm h. 55 cm
(pag. 310)

QUADRATO / SQUARE
40x40 cm h. 55 cm
(pag.310)

DIVANO ALTO / HIGH SOFA

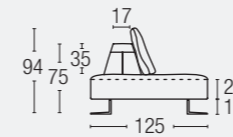
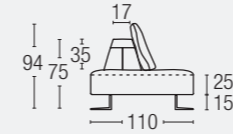

DIVANO BASSO / LOW SOFA

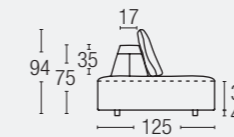
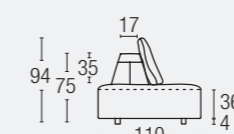

SCHIENALE / BACKREST

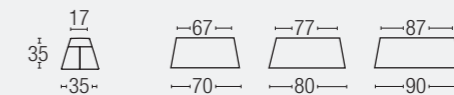

Ogni schienale ha un guancialino 60 X 60 incluso. Each backrest has a pillow 60 X 60 included.

Su richiesta guanciale/ruolo. 60 x 70. On request pillow with roll 60 X 70

BRACCIOLIO / ARMREST

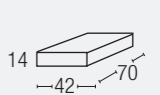

SEDUTA / SEAT

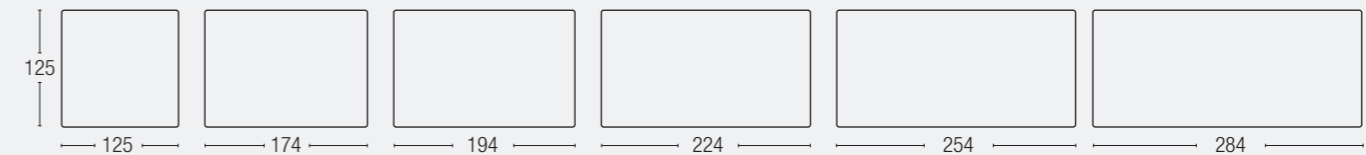
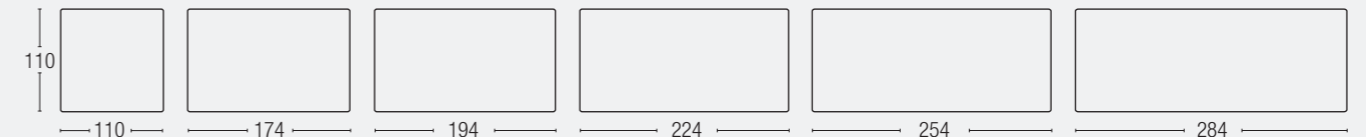

ELEMENTI SPECIALI / SPECIAL ELEMENTS

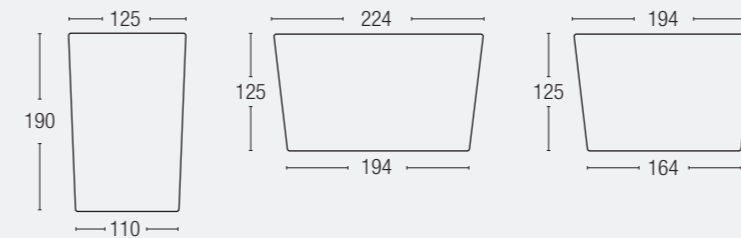

ESEMPI DI CONFIGURAZIONI CONFIGURATIONS EXAMPLES

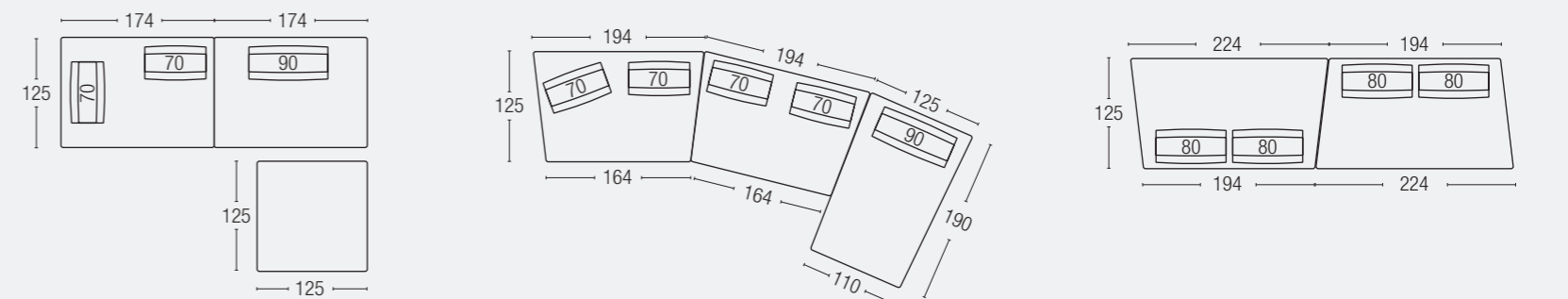
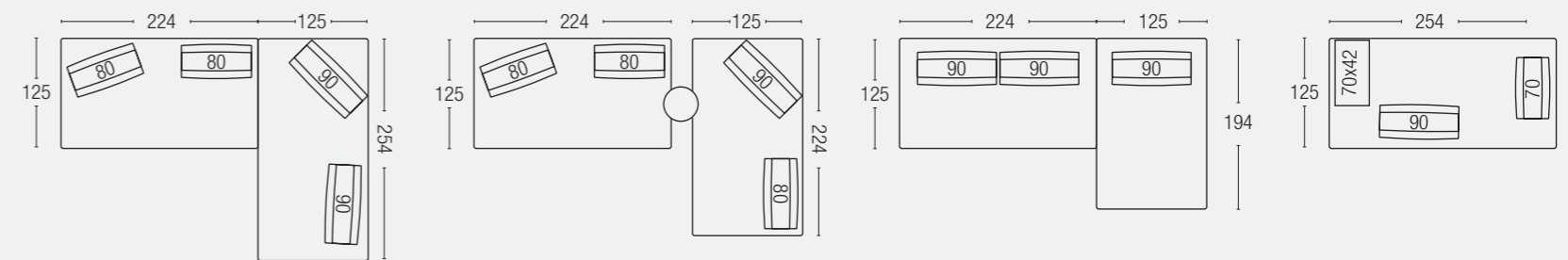



BOSTON

Pagina 158

Design:
Danilo Bonfanti

STRUTTURA

Struttura in legno e multistrato imbottita in poliuretano a quote differenziate e rivestita in resinato accoppiato dello spessore di 10 mm.

TELAIO

Telaio sotto i cuscini di seduta in multistrato.

SEDUTA

Cuscini di seduta in poliuretano densità minima 30 HR, con inserti centrali in molle, il tutto rivestito da una falda Dacron.

SCHIENALE

Cuscini schienale 100% in piuma naturale depolverizzata, lavata e sterilizzata, a camere separate orizzontalmente, con inserto in poliuretano interamente rivestiti da una tela in cotone 100%. A richiesta è possibile inserire il movimento di alzata verticale dello schienale

GUANCIALI

Guanciali 100% piuma naturale lavata, depolverizzata e sterilizzata. Misura dei guanciali 45 X 45 cm.

STRUCTURE

Laminated wood structure padded with polyurethane foam of different densities and covered in a 10 mm layer of bonded resin.

FRAME

Plywood frame supporting the seat cushions.

SEAT

Polyurethane padding seat cushions with a minimum density of 30 HR with central spring inserts, covered in a layer of Dacron.

BACKREST

Backrest cushions 100% natural dust-free, washed and sterilized down padding arranged in separate horizontal chambers with a polyurethane insert and 100% cotton fabric cover. On request vertical mechanism in the backrest

PILLOW

100% natural dust-free, washed and sterilized down pillows. Pillow size 45 X 45 cm.

DIVANO / SOFA

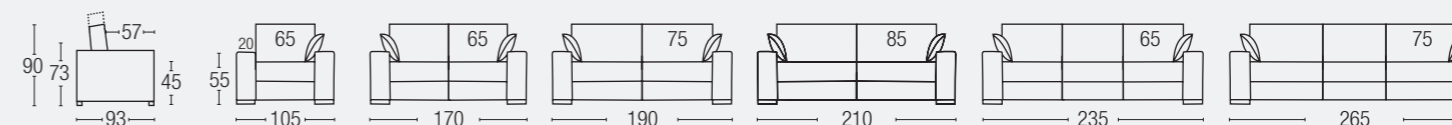

Ogni bracciolo ha un guancialino cm 45 X 45 incluso. Each armrest has a pillow cm 45 X 45 included.

POUF

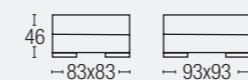

TERMINALE / ARMREST UNIT

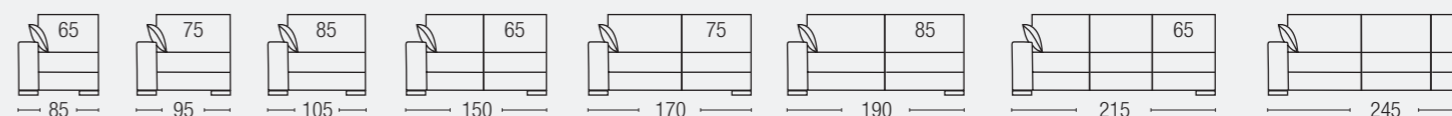

Ogni bracciolo ha un guancialino cm 45 X 45 incluso. Each armrest has a pillow cm 45 X 45 included.

ANGOLO / CORNER



PENISOLA / PENINSULA

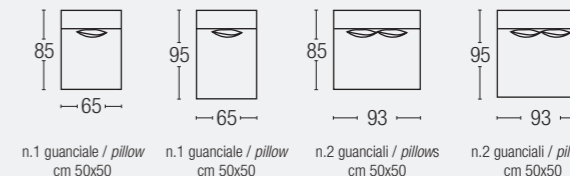

n.1 guanciaie / pillow cm 50x50

n.1 guanciaie / pillow cm 50x50

n.2 guanciali / pillows cm 50x50

n.2 guanciali / pillows cm 50x50

PIEDINI / FOOT



LISTELLO / LISTELLO FOOT

Piede disponibile in due versioni /

Foot available in two different versions

In legno tinta wengé /

Wengé coloured wood foot

h. 4 cm

In legno rivestito con lamina metallica satinato opaco /

Wood foot with a matt satin metal covering

h. 4 cm

CHAISE LONGUE

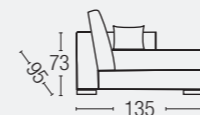

seduta a martello / "hammer" seat



BRAD

Pagina 172

Design:
Danilo Bonfanti

STRUTTURA

Struttura in legno e multistrato imbottita in poliuretano a quote differenziate e rivestita in resinato accoppiato dello spessore di 10 mm.

MOLLEGGIO

Molleggio della seduta in nastri elastici intrecciati ad alta densità.

SEDUTA

Cuscini di seduta 100% in piuma naturale depolverizzata, lavata e sterilizzata a camere separate orizzontalmente e supportati da un inserto in poliuretano.

SCHIENALE

Cuscini schienale 100% in piuma naturale depolverizzata, lavata e sterilizzata, a camere separate orizzontalmente, con inserto in poliuretano interamente rivestiti da una tela in cotone 100%.

GUANCIALI

Guanciali 100% piuma naturale lavata, depolverizzata e sterilizzata. Misura dei guanciali 45 X 45 cm e 50 X 50 cm a seconda delle composizioni.

STRUCTURE

Laminated wood structure padded with polyurethane foam of different densities and covered in a 10 mm layer of bonded resin.

SUSPENSION

The seat suspension system uses high-density intertwined elastic bands.

SEAT

Seat cushions made of 100% natural dust-free, washed and sterilized down padding arranged in separate horizontal chambers supported by a polyurethane insert.

BACKREST

Backrest cushions 100% natural dust-free, washed and sterilized down padding arranged in separate horizontal chambers with a polyurethane insert and 100% cotton fabric cover.

PILLOW

100% natural dust-free, washed and sterilized down Pillows. The pillow sizes vary based on sofa composition (size 45 x 45 cm or 50 x 50 cm).

DIVANO / SOFA

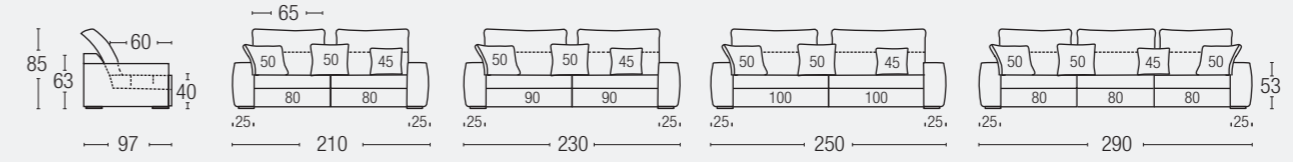

TERMINALE / ARMREST UNIT

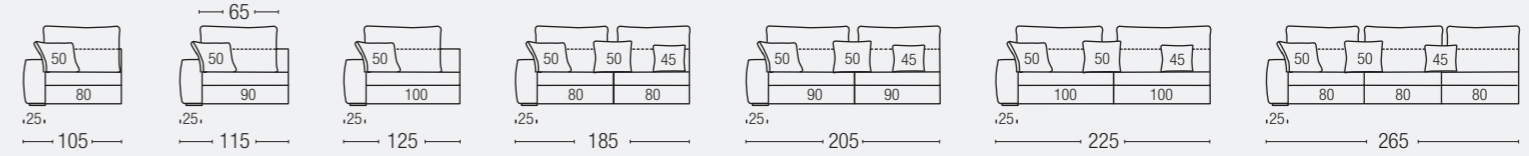

ANGOLARE CON POUF / CORNER WITH POUF

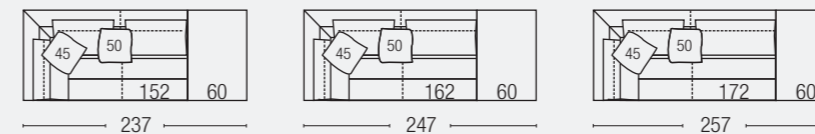

POUF

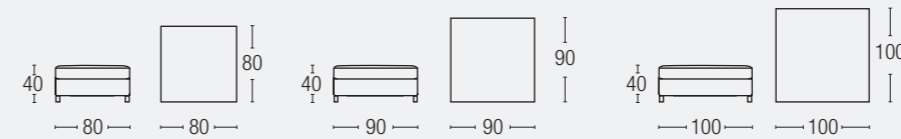

ANGOLO / CORNER

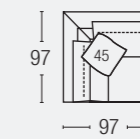

PANCA / BENCH

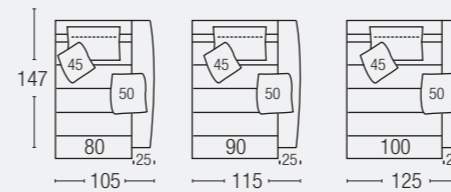

PIEDINI / FOOT

SCOMPARSA / RETRACTABLE FOOT

a scomparsa in legno cilindrico in tinta wengé /Retractable, wengé coloured, cylindrical wood foot
h. 3 cm

CUSCINI DI SEDUTA / SEAT CUSHIONS



Senza cuciture
Stitchingless

Con cuciture
With stitchings



BRAVO

Pagina 038

Design:
Danilo Bonfanti

STRUTTURA

Struttura in legno e multistrato imbottita in poliuretano a quote differenziate e rivestita in resinato accoppiato dello spessore di 10 mm.

MOLLEGGIO

Molleggio della seduta in nastri elastici intrecciati ad alta densità.

SEDUTA

Cuscini di seduta in poliuretano densità minima 30 HR rivestiti da una falda Dacron.

SCHIENALE

Cuscini schienale 50% cin fill ball (fibra poliestere siliconata cava a pallino) - 50% memory foam, a camere separate orizzontalmente interamente rivestiti da una tela in cotone 100%.

STRUCTURE

Laminated wood structure padded with polyurethane foam of different densities and covered in a 10 mm layer of bonded resin.

SUSPENSION

The seat suspension system uses high-density intertwined elastic bands.

SEAT

Polyurethane padding seat cushions with a minimum density of 30 HR covered in a layer of Dacron.

BACKREST

Backrest cushions 50% Cin Fill Ball (silicone-coated hollow polyester fibre pellets) - 50% Memory Foam arranged in separate horizontal chambers, 100% cotton fabric cover.

DIVANO / SOFA

misure di massimo ingombro a bracciolo chiuso / maximum dimensions with closed armrest

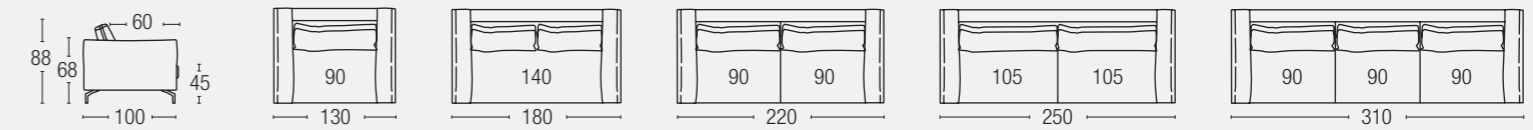

TERMINALE / ARMREST UNIT

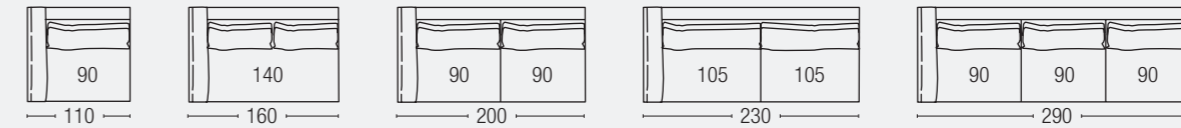

CHAISE LOUNGUE

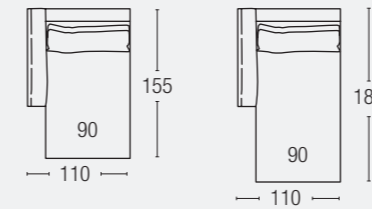

ANGOLO / CORNER

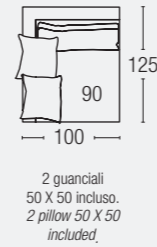

2 guanciali
50 X 50 incluso.
2 pillow 50 X 50
included.

ELEMENTO CON POUF / ELEMENT UNIT WITH POUF

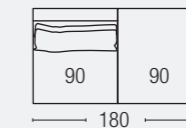

POUF

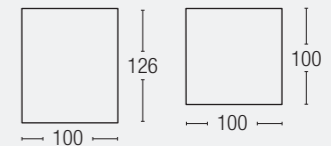

PIEDINI / FOOT

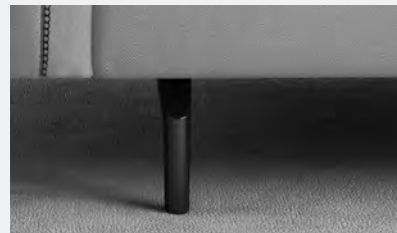

SMERALDO / SMERALDO FOOT

Alluminio cromato / Chromed aluminum
Bronzo scuro / Dark bronze
Satinato / Satin
h 15 cm



PONTE NICK / PONTE NICK FOOT

Bronzo scuro / Dark bronze
Cromato lucido / Polished chrome
Satinato / Satin
h 15 cm

BRACCIOLI / ARMREST



Bracciolo regolabile / Adjustable armrest

Misura di massimo ingombro a bracciolo chiuso
cm 20 / Maximum dimensions with closed
armrest cm 20
Misura di massimo ingombro a bracciolo
aperto cm 37 / Maximum dimensions with open
armrest cm 37.

ESEMPI DI CONFIGURAZIONI CONFIGURATIONS EXAMPLES

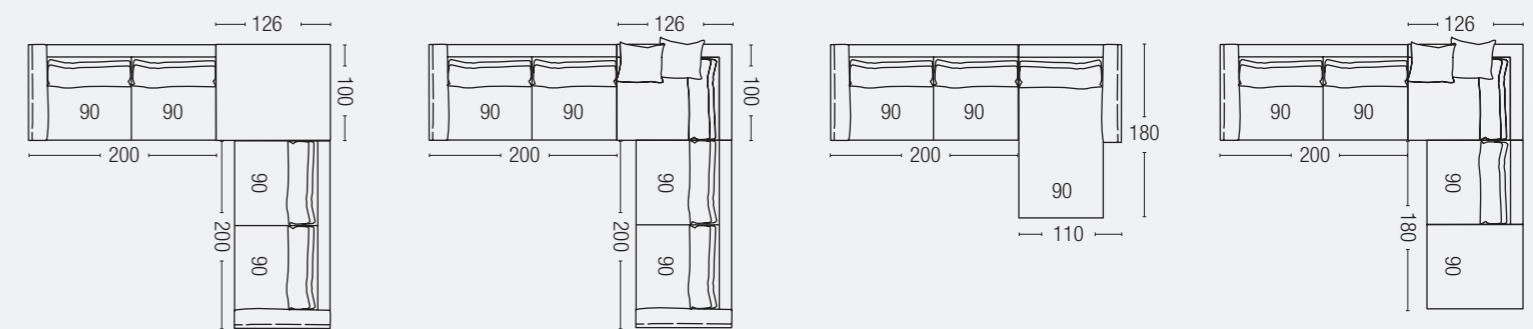

CUCITURE A CONTRASTO / CONTRAST STITCHING

CUCITURE TONO SU TONO / TONE ON TONE STITCHING



A B C D E F



CHARLIE

Pagina 164

Design:
Danilo Bonfanti

STRUTTURA

Struttura in legno e multistrato imbottita in poliuretano a quote differenziate e rivestita in resinato accoppiato dello spessore di 10 mm.

MOLLEGGIO

Molleggio della seduta in nastri elastici intrecciati ad alta densità.

SEDUTA

Cuscini di seduta in poliuretano densità minima 30 HR rivestiti da una falda Dacron.

SCHIENALE

Cuscini schienale 50% in piuma naturale depolverizzata, lavata e sterilizzata - 50% poliuretano, a camere separate orizzontalmente interamente rivestiti da una tela in cotone 100%.

GUANCIALI

Guanciali 50% piuma naturale depolverizzata, lavata e sterilizzata - 50% poliuretano. Misura dei guanciali 50 X 50 cm.

STRUCTURE

Laminated wood structure padded with polyurethane foam of different densities and covered in a 10 mm layer of bonded resin.

SUSPENSION

The seat suspension system uses high-density intertwined elastic bands.

SEAT

Polyurethane padding seat cushions with a minimum density of 30 HR covered in a layer of Dacron.

BACKREST

Backrest cushions 50% natural dust-free, washed and sterilized Down padding - 50% Polyurethane arranged in separate horizontal chambers, 100% cotton fabric cover.

PILLOW

50% natural dust-free, washed and sterilized down 50% Polyurethane Pillows. Pillow size 50 X 50 cm.

DIVANO / SOFA

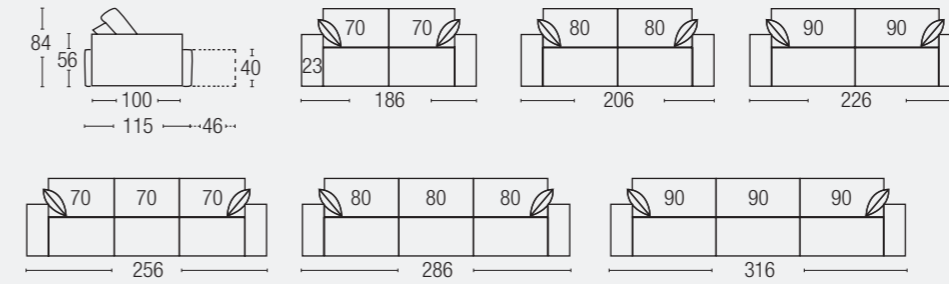

DIVANO CON CHAISE LONGUE / SOFA WITH CHAISE LONGUE

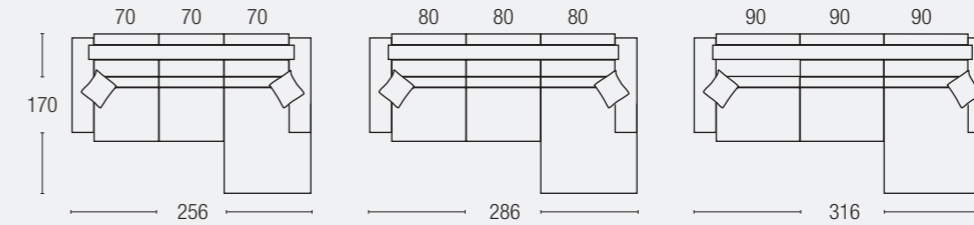

POUF

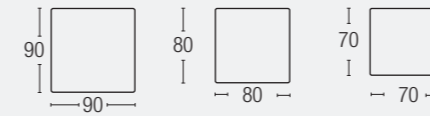

PIEDINI / FOOT



LISTELLO / LISTELLO FOOT

Legno rivestito in lamina di metallo satinato opaco
Wood Foot with a matt satin metal covering
h. 3,5 cm

DIECI

Pagina 230

Design:
Studio Archimeta



STRUTTURA

Struttura in legno e multistrato imbottita in poliuretano a quote differenziate e rivestita in resinato accoppiato dello spessore di 10 mm.

TELAIO

Telaio sotto i cuscini di seduta in multistrato per le versioni fisse.

SEDUTA - versione fissa

Cuscini di seduta in poliuretano densità minima 30 HR, con inserti centrali in molle, il tutto rivestito da una falda Dacron.

SEDUTA - versione letto

Cuscini di seduta in poliuretano densità minima 30 HR rivestiti da una falda Dacron.

SCHIENALE - sia versione letto che fissa

Cuscini schienale 50% in piuma naturale depolverizzata, lavata e sterilizzata - 50% poliuretano, a camere separate orizzontalmente interamente rivestiti da una tela in cotone 100%.

GUANCIALI

Guanciali 100% piuma naturale lavata, depolverizzata e sterilizzata. Misura dei guanciali 45 X 45 cm.

RETE E MATERASSO - versione letto

Rete a maglia elettrosaldata con materasso a molle altezza 15 cm.

S O F A - B E D



La profondità del divano con la rete aperta é di cm 217.

The depth of the sofa when the bed is open is 217 cm.

STRUCTURE

Laminated wood structure padded with polyurethane foam of different densities and covered in a 10 mm layer of bonded resin.

FRAME

Fixed versions are equipped with a plywood frame supporting the seat cushions.

SEAT - fixed version

Polyurethane padding seat cushions with a minimum density of 30 HR with central spring inserts, covered in a layer of Dacron.

SEAT - bed version

Polyurethane padding seat cushions with a minimum density of 30 HR covered in a layer of Dacron.

BACKREST- for both bed and fixed versions

Backrest cushions 50% natural dust-free, washed and sterilized Down padding – 50% Polyurethane arranged in separate horizontal chambers, 100% cotton fabric cover.

PILLOW

100% natural dust-free, washed and sterilized down Pillows. Pillow size 45 X 45 cm.

BED BASE AND MATTRESS – bed version

Electrowelded wire mesh bed base with a 15 cm spring mattress .

DIVANO / SOFA

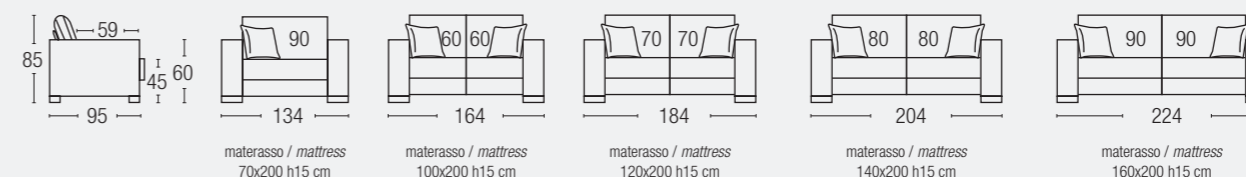

TERMINALE / ARMREST UNIT

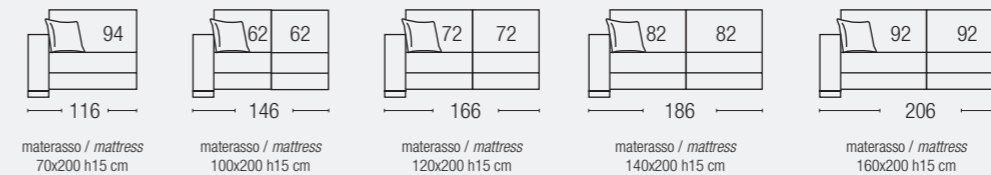

CHAISE LONGUE

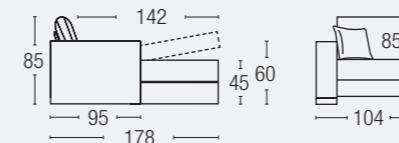

PIEDINI / FOOT



LISTELLO / LISTELLO FOOT

Legno tinta wengé / Wengé coloured wood foot
h. 5 cm



EGO

Pagina 208

Design:
Danilo Bonfanti

S O F A - B E D



La profondità del divano con la rete aperta è di cm 217.

The depth of the sofa when the bed is open is 217 cm.

STRUTTURA

Struttura in legno e multistrato imbottita in poliuretano a quote differenziate e rivestita in resinato accoppiato dello spessore di 10 mm.

TELAIO

Telaio sotto i cuscini di seduta in multistrato per le versioni fisse.

SEDUTA - sia versione letto che fissa

Cuscini di seduta 100% in piuma naturale depolverizzata, lavata e sterilizzata a camere separate orizzontalmente e supportati da un inserto in poliuretano.

GUANCIALI

Guanciali 100% piuma naturale lavata, depolverizzata e sterilizzata. Misure dei guanciali 45 X 45 cm.

RETE E MATERASSO

Rete a maglia elettrosaldata con materasso in espanso, densità 30 HR, rivestito in Aloe.

STRUCTURE

Laminated wood structure padded with polyurethane foam of different densities and covered in a 10 mm layer of bonded resin.

FRAME

Fixed versions are equipped with a plywood frame supporting the seat cushions.

SEAT - for both bed and fixed versions

Seat cushions made of 100% natural dust-free, washed and sterilized down padding arranged in separate horizontal chambers supported by a polyurethane insert.

PILLOW

100% natural dust-free, washed and sterilized down pillows. Pillow size 45 X 45 cm.

BED BASE AND MATTRESS - bed version

Electrowelded wire mesh bed base with foam 30 HR density mattress covered in a layer of Aloe.

DIVANO / SOFA

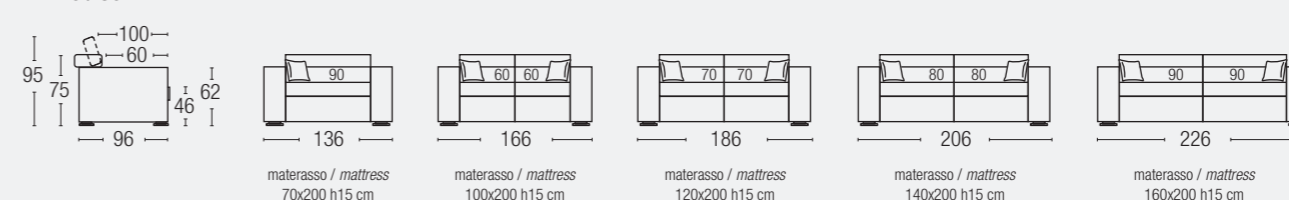

TERMINALE / ARMREST UNIT

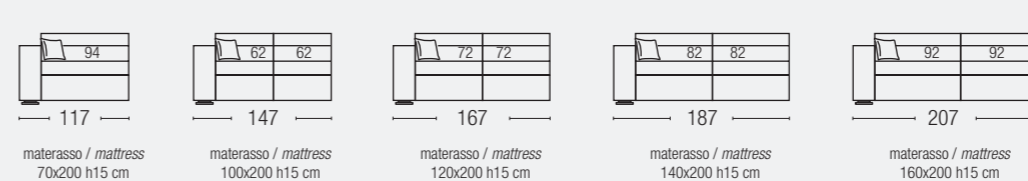

PANCA / BENCH

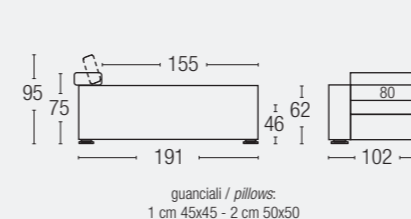

CHAISE LONGUE

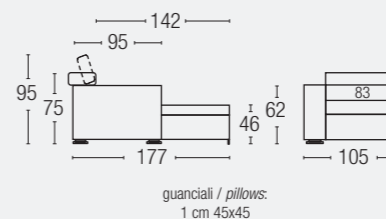

ANGOLO / CORNER

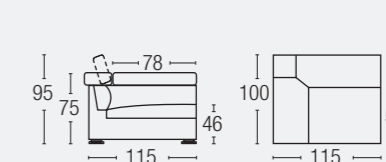

PIEDINI / FOOT



Legno rivestito metallo cromato lucido sia per le versioni letto che fisse / *Wood foot with a polished chrome covering for both bed and fixed versions* h.4 cm

POGGIATESTA / HEADREST



Poggiatesta regolabile in 6 posizioni / *Headrest adjustable in 6 positions*



FREEDOM

Pagina 006

Design:
Danilo Bonfanti

STRUTTURA

Struttura in legno e multistrato imbottita in poliuretano a quote differenziate e rivestita in resinato accoppiato dello spessore di 10 mm.

MOLLEGGIO

Molleggio della seduta in nastri elastici intrecciati ad alta densità.

SEDUTA

Cuscini di seduta 100% in piuma naturale depolverizzata, lavata e sterilizzata a camere separate orizzontalmente e supportati da un inserto in poliuretano.

SCHIENALE

Cuscini schienale 50% in piuma naturale depolverizzata, lavata e sterilizzata, a camere separate orizzontalmente e 50% poliuretano; interamente rivestiti da una tela in cotone 100%.

GUANCIALI

Guanciali 100% piuma naturale lavata, depolverizzata e sterilizzata. Misure dei guanciali 45 X 45 cm.

STRUCTURE

Laminated wood structure padded with polyurethane foam of different densities and covered in a 10 mm layer of bonded resin.

SUSPENSION

The seat suspension system uses high-density intertwined elastic bands.

SEAT

Seat cushions made of 100% natural dust-free, washed and sterilized down padding arranged in separate horizontal chambers supported by a polyurethane insert.

BACKREST

Backrest cushions 50% natural dust-free, washed and sterilized down padding arranged in separate horizontal chambers and 50% polyurethane, 100% cotton fabric cover.

PILLOW

100% natural dust-free, washed and sterilized down pillows. Pillow size 45 X 45 cm.

PIEDINI / FOOT

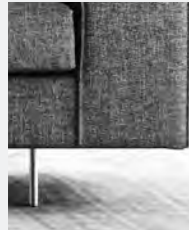

PIEDE FREEDOM / FREEDOM FOOT
Brunito / Burnished
Cromato lucido / Polished chromed
Satinato / Satin
h. 12,5 cm

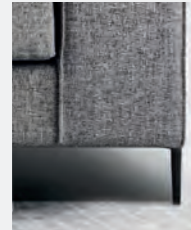

PIEDE SPILLO NICK / SPILLO NICK FOOT
Brunito / Burnished
Cromato lucido / Polished chromed
Satinato / Satin
h. 15 cm

F65-F50 / F65-F50



Sostegno cuscino schienale / Backrest cushion support
F65 L.65 cm
F50 L.50 cm

DIVANO / SOFA

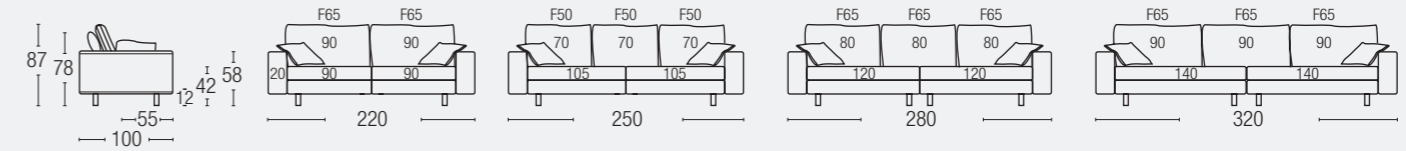

PENISOLA E ELEMENTO CENTRALE / PENINSULA AND CENTRAL ELEMENT

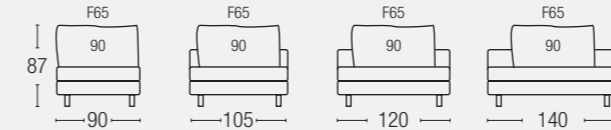

TERMINALE / ARMREST UNIT

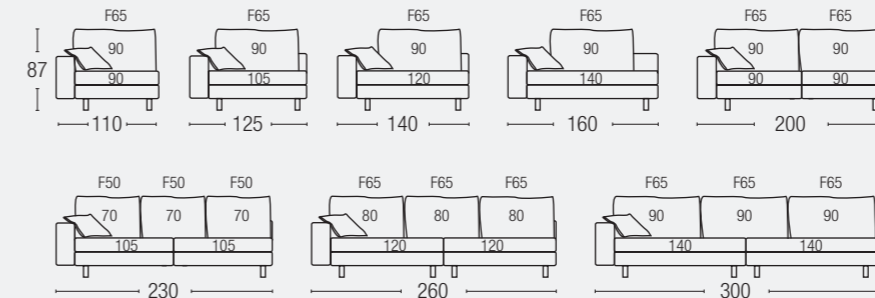

CHAISE LONGUE

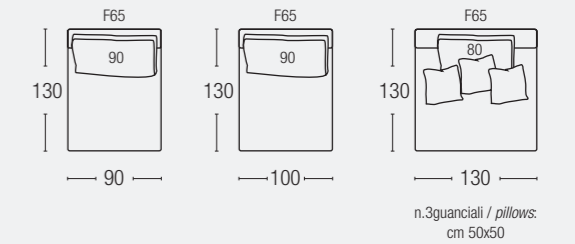

ANGOLARE CON POUF / CORNER WITH POUF

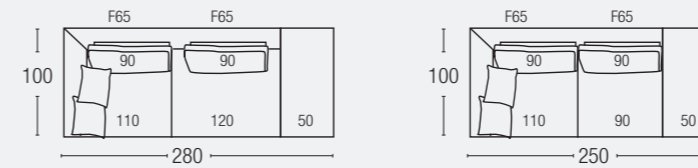

ESEMPI DI CONFIGURAZIONI / CONFIGURATIONS EXAMPLES

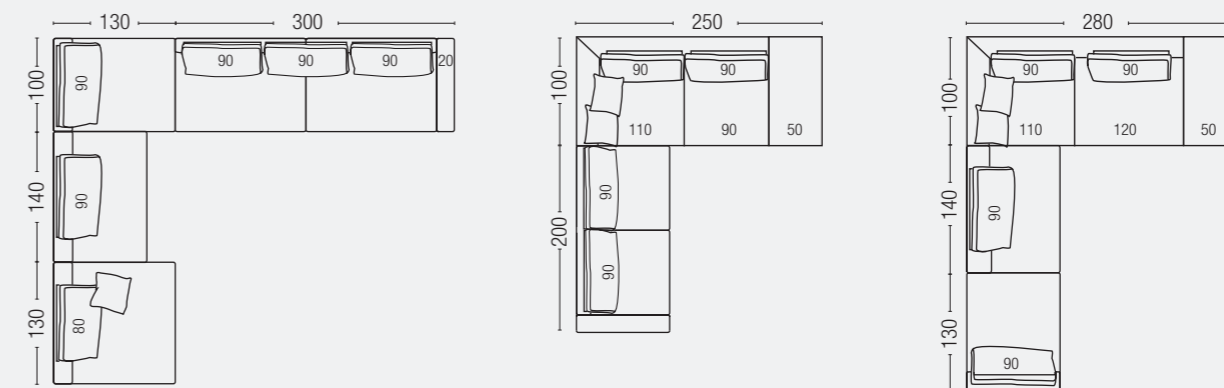



HOLÀ

Pagina 222

Design:
Danilo Bonfanti

S O F A - B E D



La rete e il materasso prendono il posto della seduta girando su se stessi e non sporgono rispetto alla profondità del divano.

The base and the mattress occupy the sitting space by revolving and don't protrude in relation to the depth of the sofa.

STRUTTURA

Struttura in legno e multistrato imbottita in poliuretano a quote differenziate e rivestita in resinato accoppiato dello spessore di 10 mm.

SEDUTA

Cuscini di seduta in poliuretano densità minima 30 HR rivestiti da una falda Dacron.

SCHIENALE

Cuscini schienale 100% in piuma naturale depolverizzata, lavata e sterilizzata, a camere separate orizzontalmente, con inserto in poliuretano interamente rivestiti da una tela in cotone 100%.

RETE E MATERASSO

Rete a maglia elettrosaldata con materasso in espanso densità 30 HR altezza 15 cm.

STRUCTURE

Laminated wood structure padded with polyurethane foam of different densities and covered in a 10 mm layer of bonded resin.

SEAT

Polyurethane padding seat cushions with a minimum density of 30 HR covered in a layer of Dacron.

BACKREST

Backrest cushions 100% natural dust-free, washed and sterilized down padding arranged in separate horizontal chambers with a polyurethane insert and 100% cotton fabric cover.

BED BASE AND MATTRESS

Electrowelded wire mesh bed base, with a 15 cm H - 30 HR density - Polyurethane mattress.

DIVANO / SOFA

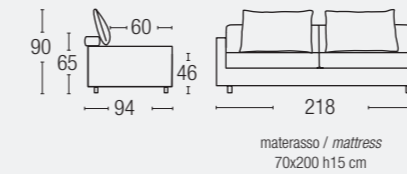

PIEDINI / FOOT



Piede legno tinta noce
4 X 4 cm
/ *Walnut coloured
wood foot 4 X 4 cm
h. 8 cm*



JOY

Design:
Danilo Bonfanti

Pagina 118

STRUTTURA

Struttura in legno e multistrato imbottita in poliuretano a quote differenziate e rivestita in resinato accoppiato dello spessore di 10 mm.

MOLLEGGIO

Molleggio della seduta in nastri elastici intrecciati ad alta densità.

SEDUTA

Cuscini di seduta in poliuretano densità minima 30 HR rivestiti da una falda Dacron.

SCHIENALE

Cuscini schienale 100% in piuma naturale depolverizzata, lavata e sterilizzata, a camere separate orizzontalmente, con inserto in poliuretano interamente rivestiti da una tela in cotone 100%.

GUANCIALI

Guanciali 100% piuma naturale lavata, depolverizzata e sterilizzata. Misura dei guanciali 45 X 45 cm.

STRUCTURE

Laminated wood structure padded with polyurethane foam of different densities and covered in a 10 mm layer of bonded resin.

SUSPENSION

The seat suspension system uses high-density intertwined elastic bands.

SEAT

Polyurethane padding seat cushions with a minimum density of 30 HR covered in a layer of Dacron.

BACKREST

Backrest cushions 100% natural dust-free, washed and sterilized down padding arranged in separate horizontal chambers with a polyurethane insert and 100% cotton fabric cover.

PILLOW

100% natural dust-free, washed and sterilized down pillows. Pillow size 45 X 45 cm.

PIEDINI / FOOT



A SCOMPARSA / RETRACTABLE FOOT

A scomparsa in legno cilindrico in tinta wengé
Retractable, wengé coloured, cylindrical wood foot
h. 3 cm

DIVANO / SOFA

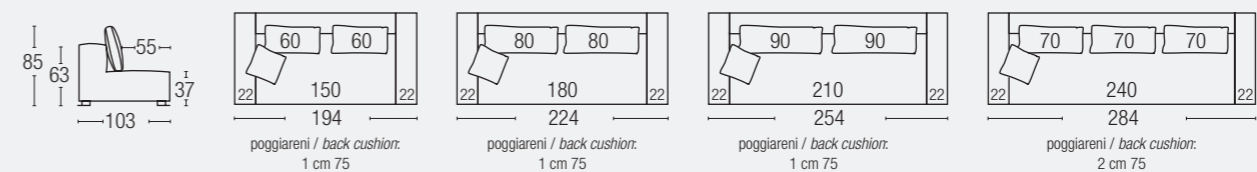

TERMINALE / ARMREST UNIT

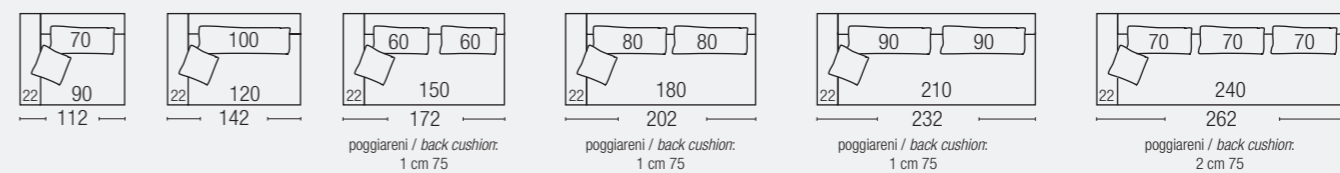

ELEMENTO CENTRALE / CENTRAL ELEMENT

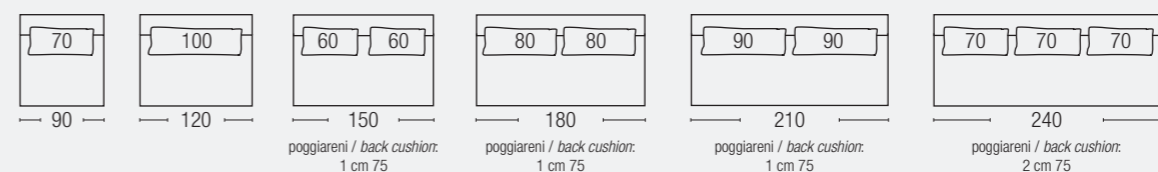

TERMINALE ANGOLARE CON POUF / CORNER ARMREST WITH POUF

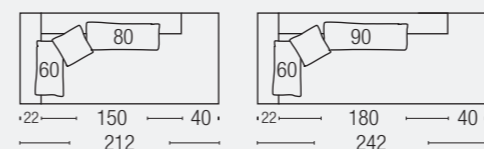

ELEMENTO CON POUF / ELEMENT WITH POUF

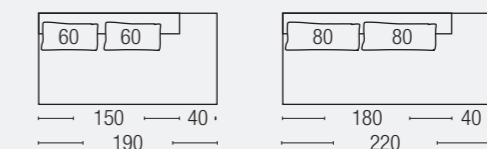

CHAISE LONGUE RELAX*

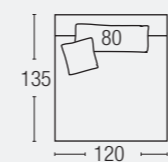

RELAX*

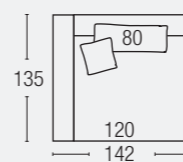

POUF

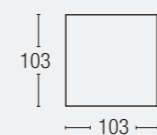



LINK

Pagina 102

Design:
Danilo Bonfanti

STRUTTURA

Struttura in legno e multistrato imbottita in poliuretano a quote differenziate e rivestita in resinato accoppiato dello spessore di 10 mm.

MOLLEGGIO

Molleggio della seduta in nastri elastici intrecciati ad alta densità.

SEDUTA

Cuscini di seduta in poliuretano densità minima 30 HR rivestiti da una falda Dacron.

SCHIENALE

Cuscini schienale 40% poliuretano - 40% cin fill ball (fibra poliestere siliconata cava a pallino) - 20% memory foam, a camere separate orizzontalmente interamente rivestiti da una tela in cotone 100%.

GUANCIALI

Guanciali 100% piuma naturale lavata, depolverizzata e sterilizzata. Misura dei guanciali 50 X 50 cm.

STRUCTURE

Laminated wood structure padded with polyurethane foam of different densities and covered in a 10 mm layer of bonded resin.

SUSPENSION

The seat suspension system uses high-density intertwined elastic bands.

SEAT

Polyurethane padding seat cushions with a minimum density of 30 HR covered in a layer of Dacron.

BACKREST

Backrest cushions 40% Polyurethane - 40% Cin Fill Ball (silicone-coated hollow polyester fibre pellets) - 20% Memory Foam arranged in separate horizontal chambers, 100% cotton fabric cover.

PILLOW

100% natural dust-free, washed and sterilized down pillows. Pillow size 50X 50 cm.

DIVANO / SOFA

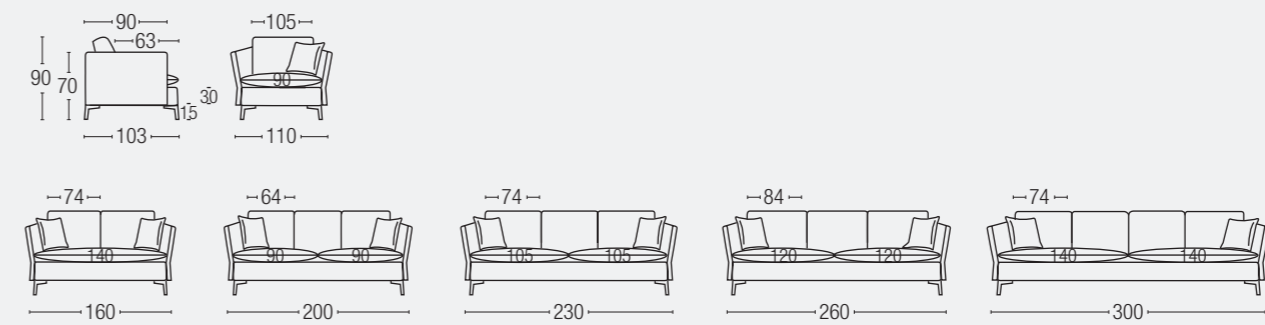

TERMINALE / ARMREST UNIT

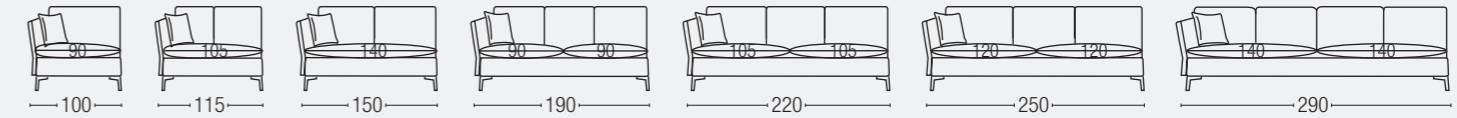

CHAISE LONGUE

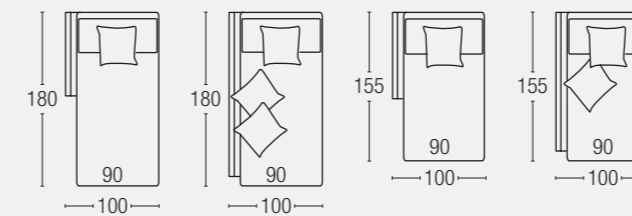

ANGOLO / CORNER

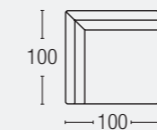

POUF

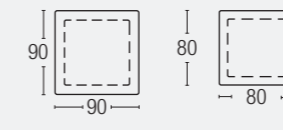

GUANCIALI / PILLOWS

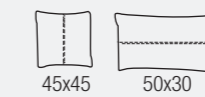

PIEDINI / FOOT



Cromato / Chromed
Brunito / Burnished
h. 15 cm

CUCITURE A CONTRASTO/ CONTRAST STITCHING

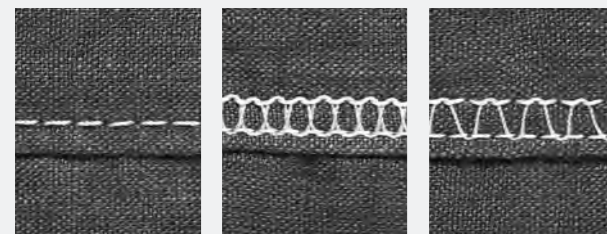

A

B

C

CUCITURE TONO SU TONO/ TONE ON TONE STITCHING



D

E

F

MADISON

Pagina 232

Design:
Studio Archimeta



S O F A - B E D



La profondità del divano con la rete aperta é di cm 214.

The depth of the sofa when the bed is open is 214 cm.

STRUTTURA

Struttura in legno e multistrato imbottita in poliuretano a quote differenziate e rivestita in resinato accoppiato dello spessore di 10 mm.

TELAIO

Telaio sotto i cuscini di seduta in multistrato per le versioni fisse.

SEDUTA - versione fissa

Cuscini di seduta in poliuretano densità minima 30 HR, con inserti centrali in molle, il tutto rivestito da una falda Dacron.

SEDUTA - versione letto

Cuscini di seduta in poliuretano densità minima 30 HR rivestiti da una falda Dacron.

SCHIENALE - sia versioni letto che fissa

Cuscini di schienale in poliuretano densità 25 HR rivestiti da una falda di Dacron.

GUANCIALI

Guanciali 100% piuma naturale lavata, depolverizzata e sterilizzata. Misura dei guanciali 55 X 55 cm.

RETE E MATERASSO

Rete a maglia elettrosaldata con materasso a molle H 15 cm.

STRUCTURE

Laminated wood structure padded with polyurethane foam of different densities and covered in a 10 mm layer of bonded resin.

FRAME

Fixed versions are equipped with a plywood frame supporting the seat cushions.

SEAT - fixed version

Polyurethane padding seat cushions with a minimum density of 30 HR with central spring inserts, covered in a layer of Dacron.

SEAT - bed version

Polyurethane padding seat cushions with a minimum density of 30 HR covered in a layer of Dacron.

BACKREST- for both bed and fixed versions

Polyurethane padding backrest cushions with a minimum density of 25 HR covered in a layer of Dacron.

PILLOW

100% natural dust-free, washed and sterilized down pillows. Pillow size 55 X 55 cm.

BED BASE AND MATTRESS – bed version

Electrowelded wire mesh bed base with a 15 cm spring mattress.

DIVANO / SOFA

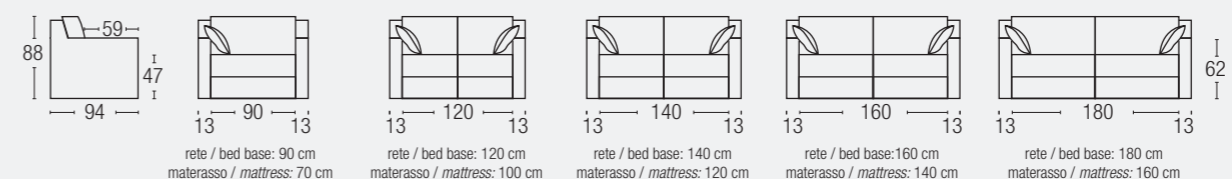

CHAISE LONGUE

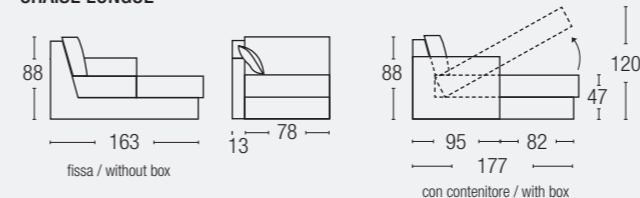

BRACCIOLI / ARMRESTS

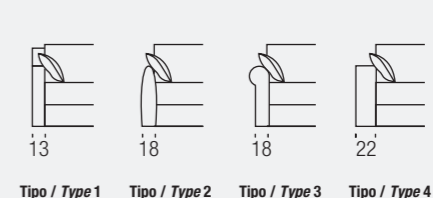

PIEDINI / FOOT



A SCOMPARSA / RETRACTABLE FOOT

a scomparsa in legno tinta noce scuro/
Retractable dark walnut coloured wood foot
h. 5 cm
Per braccioli tipo / For armrest type: 1 / 2 / 3



LISTELLO / LISTELLO FOOT

Wengè / *Wengè*
h. 5 cm
Per braccioli tipo / For armrest type: 4

BRACCIOLI / ARMREST



TIPO / TYPE 1

TIPO / TYPE 2

TIPO / TYPE 3

TIPO / TYPE 4



MASTER

Pagina 152

Design:
Studio Archimeta

STRUTTURA

Struttura in legno e multistrato imbottita in poliuretano a quote differenziate e rivestita in resinato accoppiato dello spessore di 10 mm.

TELAIO

Telaio sotto i cuscini di seduta in multistrato.

SEDUTA

Cuscini di seduta in poliuretano densità minima 30 HR, con inserti centrali in molle, il tutto rivestito da una falda Dacron.

SCHIENALE

Schienale strutturale in espanso

GUANCIALI

Guanciali 100% piuma naturale lavata, depolverizzata e sterilizzata. Misura dei guanciali 50 X 50 cm.

STRUCTURE

Laminated wood structure padded with polyurethane foam of different densities and covered in a 10 mm layer of bonded resin.

FRAME

Plywood frame supporting the seat cushions.

SEAT

Polyurethane padding seat cushions with a minimum density of 30 HR with central spring inserts, covered in a layer of Dacron.

BACKREST

Foam structural backrest.

PILLOW

100% natural dust-free, washed and sterilized down pillows. Pillow size 50 X 50 cm.

DIVANO / SOFA

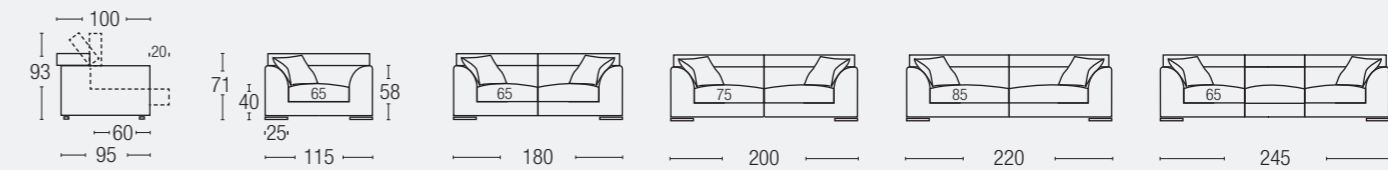

TERMINALE / ARMREST UNIT

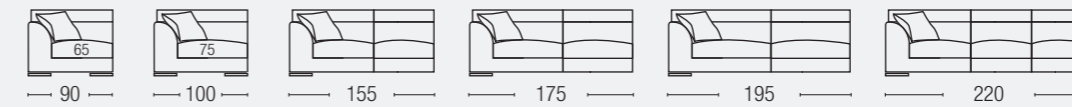

PENISOLA / PENINSULA

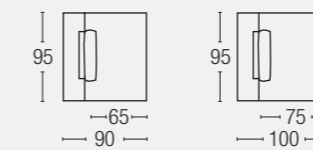

POUF

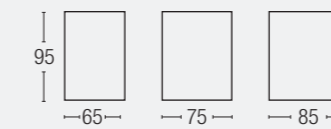

PANCA / BENCH

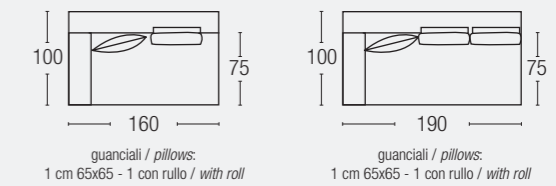

ANGOLO / CORNER

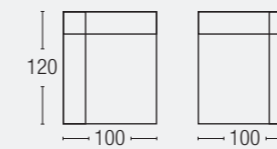

con movimento su entrambe gli schienali
Movement on both backrests

GUANCIALI / PILLOWS



PIEDINI / FOOT



LISTELLO / LISTELLO FOOT

Cromato lucido / Polished chromed
Satinato opaco / Matt satin
Legno colore wengè / Wengè coloured wood
h. 6 cm

POGGIATESTA / HEADREST

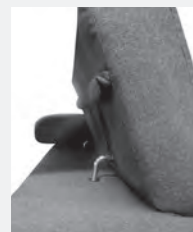

Poggiatesta regolabile in 6 posizioni
Headrest adjustable in 6 positions

SEDUTA / SEAT



Seduta con avanzamento di 20 cm
Seat with extension of 20 cm



NICK

Pagina 072

Design:
Danilo Bonfanti

STRUTTURA

Struttura in legno e multistrato imbottita in poliuretano a quote differenziate e rivestita in resinato accoppiato dello spessore di 10 mm.

TELAIO

Telaio sotto i cuscini di seduta in multistrato.

SEDUTA

Cuscini di seduta in poliuretano densità minima 30 HR, con inserti centrali a molle insacchettate, il tutto rivestito da una falda Dacron.

SCHIENALE

Cuscini di schienale in poliuretano densità 25 HR rivestiti da una falda di Dacron.

GUANCIALI

Guanciali 100% piuma naturale lavata, depolverizzata e sterilizzata. Misura dei guanciali 50 X 50 cm.

STRUCTURE

Laminated wood structure padded with polyurethane foam of different densities and covered in a 10 mm layer of bonded resin.

FRAME

Plywood frame supporting the seat cushions.

SEAT

Polyurethane padding seat cushions with a minimum density of 30 HR with central spring inserts, covered in a layer of Dacron.

BACKREST

Polyurethane padding backrest cushions with a minimum density of 25 HR covered in a layer of Dacron.

PILLOW

100% natural dust-free, washed and sterilized down pillows. Pillow size 50 X 50 cm.

DIVANO / SOFA

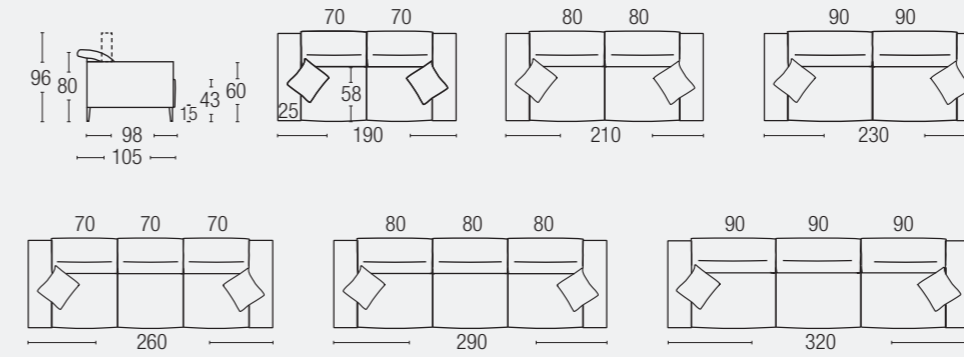

TERMINALE / ARMREST UNIT

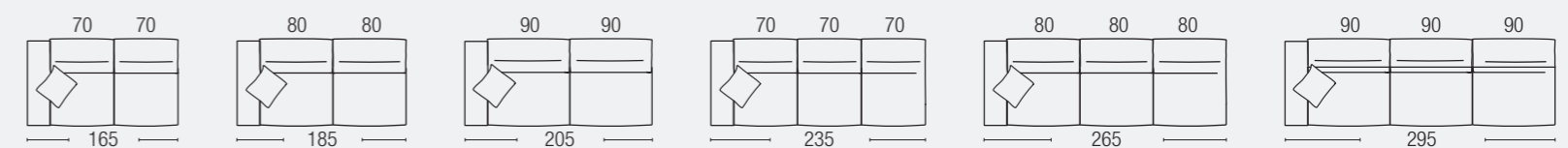

ANGOLO / CORNER



guanciali / pillows:
1 cm 65x65 - 2 cm 50x50

ANGOLARE CON POUF / CORNER WITH POUF

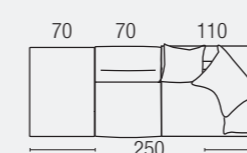

guanciali / pillows:
1 cm 65x65 - 2 cm 50x50

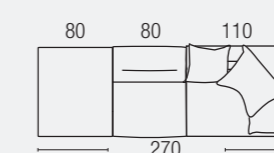

guanciali / pillows:
1 cm 65x65 - 2 cm 50x50

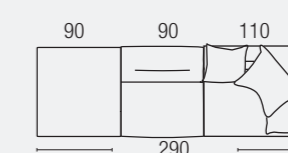

guanciali / pillows:
1 cm 65x65 - 2 cm 50x50

PIEDINI / FOOT



PONTE NICK / PONTE NICK FOOT

Brunito / Burnished
Cromato lucido / Polished chrome
Satinato / Satin
h. 15 cm
A richiesta / On request:
- RAL verniciato opaco / Matt RAL varnished



SPILLO NICK / SPILLO NICK FOOT

Brunito / Burnished
Cromato lucido / Polished chrome
Satinato / Satin
h. 15 cm
A richiesta / On request:
- RAL verniciato opaco / Matt RAL color

BRACCIOLI / ARMREST



Bracciolo 15 cm
Armrest 15 cm



Bracciolo 25 cm
Armrest 25 cm

CHAISE LOUNGUE PANCA / BENCH

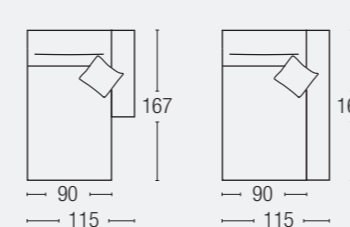

PENISOLA CON RIBALTA / PENINSULA WITH FLAP

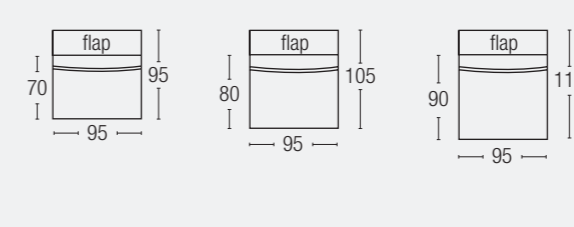

POUF H.43 CM

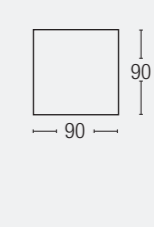



NINNA

Pagina 234

ARMCHAIR - BED



La profondità del divano con la rete aperta é di cm 196.

The depth of the sofa when the bed is open is 196 cm.

STRUTTURA

Struttura in legno e multistrato imbottita in poliuretano a quote differenziate e rivestita in resinato accoppiato dello spessore di 10 mm.

GUANCIALE

Guanciale 100% piuma naturale lavata, depolverizzata e sterilizzata. Misura del guanciale 40 X 40 cm.

STRUCTURE

Laminated wood structure padded with polyurethane foam of differing densities and covered in 10 mm thick bonded resin.

PILLOW

100% natural dust-free, washed and sterilized down pillows. Pillow size 40 X 40 cm.

SEDUTA

Cuscini di seduta in poliuretano densità minima 30 HR rivestiti da una falda Dacron.

RETE E MATERASSO

Rete a maglia elettrosaldata con materasso a molle altezza 13 cm.

SEAT

Polyurethane padding seat cushions with a minimum density of 30 HR covered in a layer of Dacron.

BED BASE AND MATTRESS

Electrowelded wire mesh bed base with a 13 cm spring mattress.

POLTRONA / ARMCHAIR

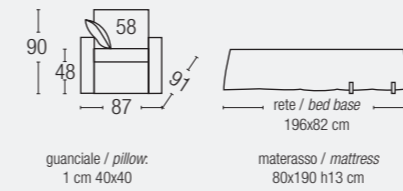

NANNA

Pagina 235

POUF - BED



La profondità del divano con la rete aperta é di cm 196.

The depth of the sofa when the bed is open is 196 cm.

SEDUTA

Cuscini di seduta in poliuretano densità minima 30 HR rivestiti da una falda Dacron.

SEAT

Polyurethane padding seat cushions with a minimum density of 30 HR covered in a layer of Dacron.

RETE E MATERASSO

Rete a maglia elettrosaldata con materasso a molle altezza 13 cm

BED BASE AND MATTRESS

Electrowelded wire mesh bed base with a 13 cm spring mattress.

POUF

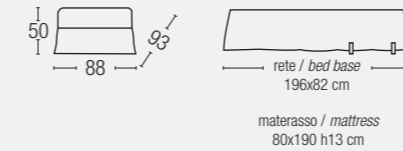



Design:
Studio Archimeta

STRUTTURA

Struttura in legno e multistrato imbottita in poliuretano a quote differenziate e rivestita in resinato accoppiato dello spessore di 10 mm.

TELAIO

Telaio sotto i cuscini di seduta in multistrato per le versioni fisse.

SEDUTA - versione fissa

Cuscini di seduta in poliuretano densità minima 30 HR, con inserti centrali in molle, il tutto rivestito da una falda Dacron.

SEDUTA - versione letto

Cuscini di seduta in poliuretano densità minima 30 HR rivestiti da una falda Dacron.

SCHIENALE - sia versione letto che fissa

Cuscini schienale 50% in piuma naturale depolverizzata, lavata e sterilizzata - 50% poliuretano, a camere separate orizzontalmente interamente rivestiti da una tela in cotone 100%.

GUANCIALI

Guanciali 100% piuma naturale lavata, depolverizzata e sterilizzata. Misura dei guanciali 45 X 45 cm.

RETE E MATERASSO - versione letto

Rete a maglia elettrosaldada con materasso a molle altezza 15 cm.

S O F A - B E D



La profondità del divano con la rete aperta é di cm 217.

The depth of the sofa when the bed is open is 217 cm.

STRUCTURE

Laminated wood structure padded with polyurethane foam of different densities and covered in a 10 mm layer of bonded resin.

FRAME

Fixed versions are equipped with a plywood frame supporting the seat cushions.

SEAT - Fixed Version

Polyurethane padding seat cushions with a minimum density of 30 HR with central spring inserts, covered in a layer of Dacron.

SEAT - bed version

Polyurethane padding seat cushions with a minimum density of 30 HR covered in a layer of Dacron.

BACKREST - for both bed and fixed versions

Backrest cushions 50% natural dust-free, washed and sterilized Down padding – 50% Polyurethane arranged in separate horizontal chambers, 100% cotton fabric cover.

PILLOW

100% natural dust-free, washed and sterilized down pillows. Pillow size 45 X 45 cm.

BED BASE AND MATTRESS - bed version

Electrowelded wire mesh bed base with a 15 cm spring mattress.

DIVANO / SOFA

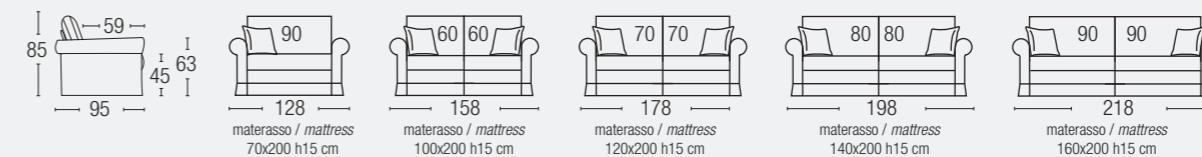

TERMINALE / ARMREST UNIT

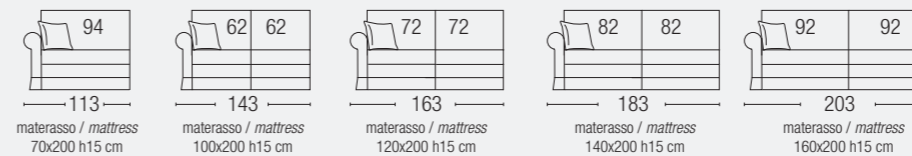

CHAISE LONGUE

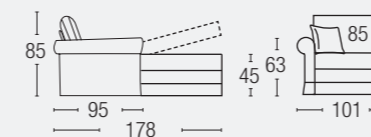

PIEDINI / FOOT



A SCOMPARSA / RETRACTABLE FOOT

Piede a scomparsa - versione fissa

Retractable foot - Fixed version

h. 5 cm

Piede a scomparsa - versione letto

Retractable foot - bed version

h. 8 cm



PIUMA

Pagina 200

S O F A - B E D



La profondità del divano con la rete aperta é di cm 235.

The depth of the sofa when the bed is open is 235 cm.

STRUTTURA

Struttura in legno e multistrato imbottita in poliuretano a quote differenziate e rivestita in resinato accoppiato dello spessore di 10 mm.

MOLLEGGIO

Molleggio della seduta in nastri elastici intrecciati ad alta densità.

SEDUTA DI SERIE - sia versione fissa che letto

Cuscini di seduta in poliuretano densità minima 30 HR, con inserti centrali in molle, il tutto rivestito da una falda Dacron.

SEDUTA - su richiesta - sia versione fissa che letto

Cuscini di seduta 100% in piuma naturale depolverizzata, lavata e sterilizzata a camere separate orizzontalmente e supportati da un inserto in poliuretano.

SCHIENALE E BRACCIOLI - sia versione fissa che letto

Cuscini di schienale e braccioli 100% in piuma naturale depolverizzata, lavata e sterilizzata, a camere separate orizzontalmente, con inserto in poliuretano interamente rivestiti da una tela in cotone 100%.

RETE E MATERASSO

Rete a maglia metallica o a doghe in legno di faggio. Materasso H 7 cm in espanso.

STRUCTURE

Laminated wood structure padded with polyurethane foam of different densities and covered in a 10 mm layer of bonded resin.

SUSPENSION

The seat suspension system uses high-density intertwined elastic bands.

STANDARD SEAT - for both fixed and bed versions

Polyurethane padding seat cushions with a minimum density of 30 HR with central spring inserts, covered in a layer of Dacron.

SEAT AVAILABLE ON REQUEST - for both fixed and bed versions

Seat cushions made of 100% natural dust-free, washed and sterilized down padding arranged in separate horizontal chambers supported by a polyurethane insert.

BACKREST AND ARMS - for both fixed and bed versions

Backrest cushions 100% natural dust-free, washed and sterilized down padding arranged in separate horizontal chambers with a polyurethane insert and 100% cotton fabric cover.

BED BASE AND MATTRESS - bed version

Metal wire mesh or beechwood slat bed base. 7 cm polyurethane Mattress.

DIVANO / SOFA

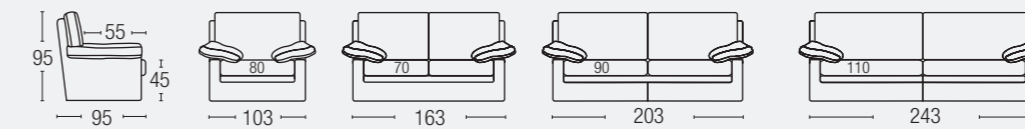

DIVANO CON LETTO / SOFA BED

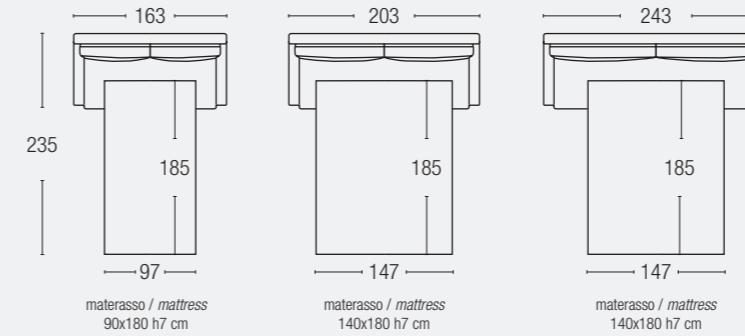

ELEMENTO CENTRALE / CENTRAL UNIT



TERMINALE / ARMREST UNIT

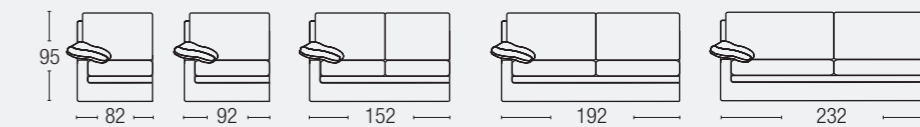

ANGOLO / CORNER



POUF

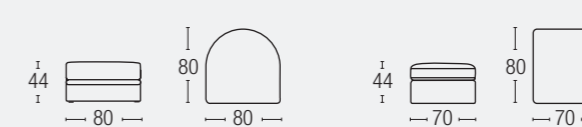

CHAISE LONGUE

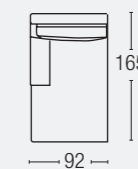

PIEDINI / FOOT



Piede a scomparsa / Retractable foot
H 2,5 cm



PLANO

Pagina 182

Design:
Danilo Bonfanti

STRUTTURA

Struttura in legno e multistrato imbottita in poliuretano a quote differenziate e rivestita in resinato accoppiato dello spessore di 10 mm.

MOLLEGGIO

Molleggio della seduta in nastri elastici intrecciati ad alta densità.

SEDUTA

Cuscini di seduta in poliuretano densità minima 30 HR rivestiti da una falda Dacron.

SCHIENALE

Schienale standard: cuscini 50% in piuma naturale depolverizzata, lavata e sterilizzata - 50% poliuretano, a camere separate orizzontalmente interamente rivestiti da una tela in cotone 100%.

Schienale su richiesta: cuscini 50% in memory foam - 50% in poliuretano a camere separate orizzontalmente interamente rivestiti da una tela in cotone 100%.

GUANCIALI

Guanciali 50% piuma naturale depolverizzata, lavata e sterilizzata - 50% poliuretano. Misura dei guanciali 50X50 cm.

STRUCTURE

Laminated wood structure padded with polyurethane foam of different densities and covered in a 10 mm layer of bonded resin.

SUSPENSION

The seat suspension system uses high-density intertwined elastic bands.

SEAT

Polyurethane padding seat cushions with a minimum density of 30 HR covered in a layer of Dacron.

BACKREST

Standard: backrest cushions 50% natural dust-free, washed and sterilized Down padding - 50% Polyurethane arranged in separate horizontal chambers, 100% cotton fabric cover.

Backrest on request: backrest cushions 50% memory foam - 50% polyurethane arranged in separate horizontal chambers, 100% cotton fabric cover.

PILLOW

50% natural dust-free, washed and sterilized down 50% Polyurethane Pillows. Pillow size 50 X 50 cm.

PIEDINI / FOOT



BISCOTTO / BISCOTTO FOOT

In legno, frontale rivestito in metallo cromato lucido
Wood foot with front covered in polished chromed metal
h. 7,5 cm
A richiesta / On request h. 9,5 cm

PLANO PLUS



DIVANO PLANO
PLANO SOFA

+ BASE POUF
POUF BASE
DX/SX



+ CUSCINO POUF
PILLOW POUF
DX/SX



Guarda il video
Watch the video

CUCITURE A CONTRASTO/ CONTRAST STITCHING

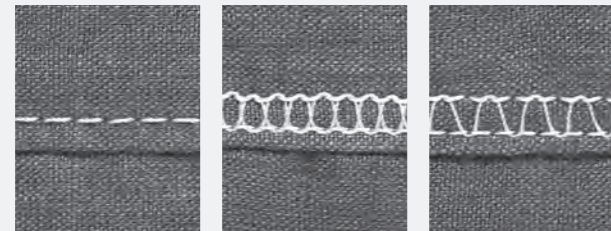

A B C

CUCITURE TONO SU TONO/ TONE ON TONE STITCHING



D E F

DIVANO / SOFA

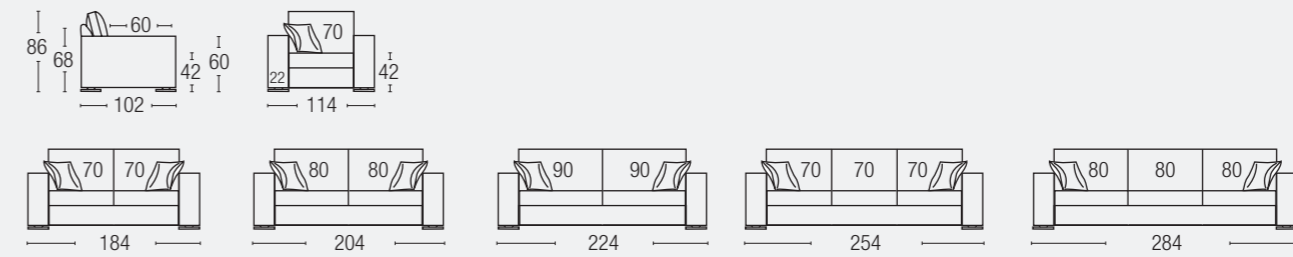

TERMINALE / ARMREST UNIT

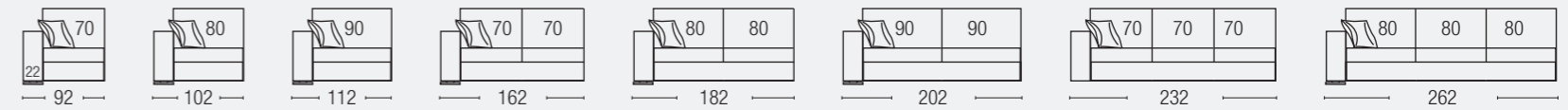

POUF

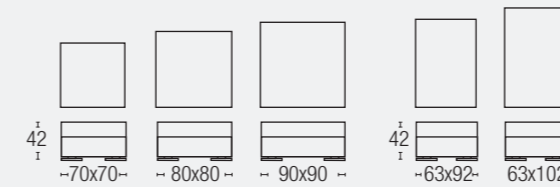

CHAISE LONGUE

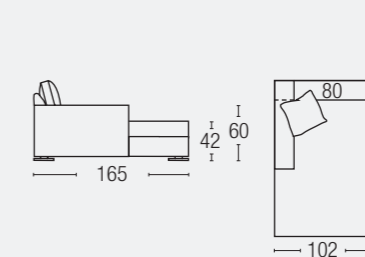

PENNISOLA / PENINSULA

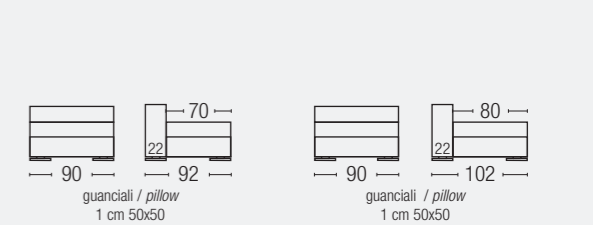

ANGOLO / CORNER

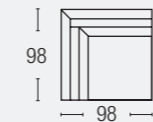

GUANCIALI / PILLOWS

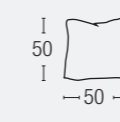

PLANO PLUS

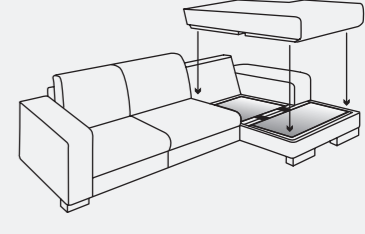
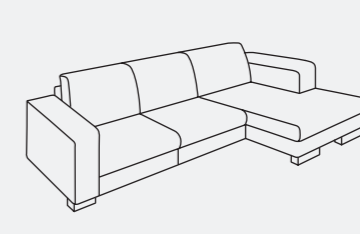
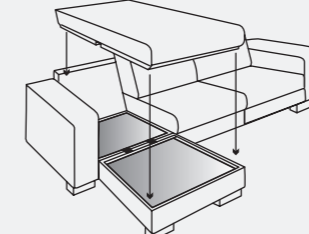
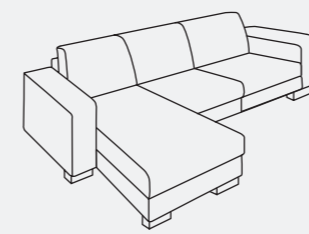

COMPOSIZIONE REVERSIBILE / REVERSIBLE COMPOSITION

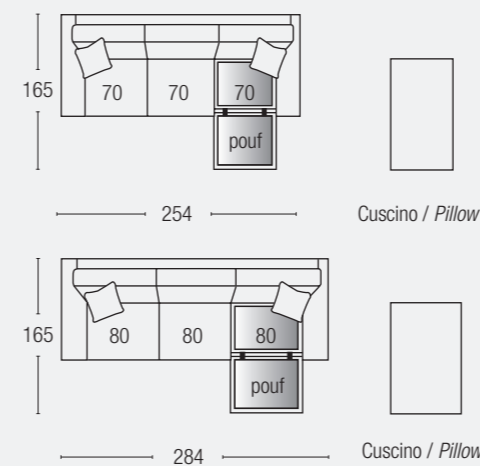

COMPOSIZIONE DX-SX / RIGHT-LEFT COMPOSITION

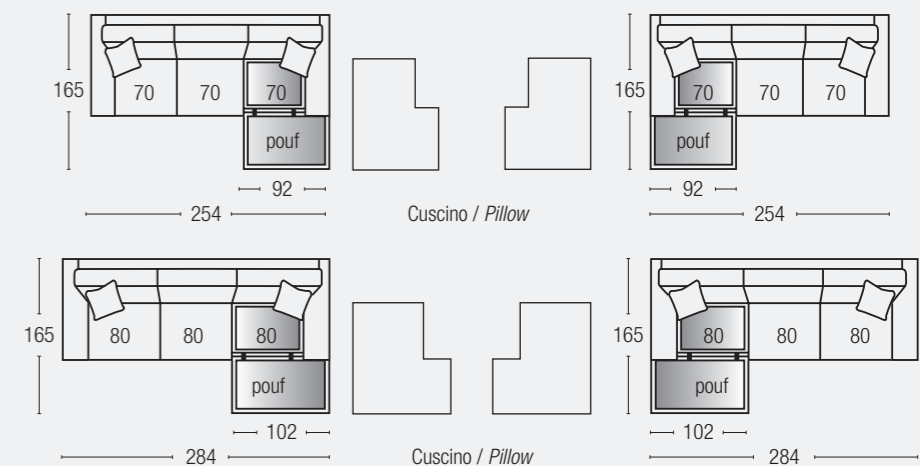



PLAY

Pagina 144

Design:
Danilo Bonfanti

STRUTTURA

Struttura in legno e multistrato imbottita in poliuretano a quote differenziate e rivestita in resinato accoppiato dello spessore di 10 mm.

MOLLEGGIO

Molleggio della seduta in nastri elastici intrecciati ad alta densità.

SEDUTA

Cuscini di seduta in poliuretano densità minima 30 HR rivestiti da una falda Dacron.

SCHIENALE

Cuscini di schienale in poliuretano densità minima 25 HR rivestiti da una falda Dacron.

GUANCIALI

Guanciali 100% in piuma naturale lavata, depolverizzata e sterilizzata. Misura dei guanciali 45 X 45 cm.

STRUCTURE

Laminated wood structure padded with polyurethane foam of different densities and covered in a 10 mm layer of bonded resin.

SUSPENSION

The seat suspension system uses high-density intertwined elastic bands.

SEAT

Polyurethane padding seat cushions with a minimum density of 30 HR covered in a layer of Dacron.

BACKREST

Polyurethane padding backrest cushions with a minimum density of 25 HR covered in a layer of Dacron.

PILLOW

100% natural dust-free, washed and sterilized down Pillows. Pillow size 45 X 45 cm.

DIVANO / SOFA

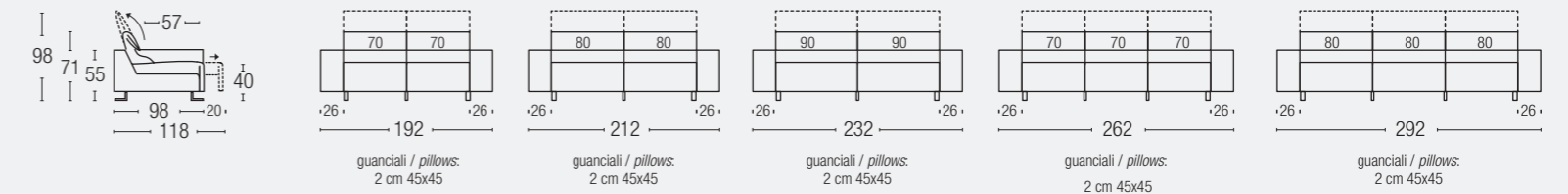

POLTRONA / ARMCHAIR

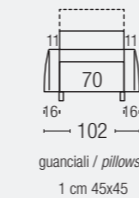

TERMINALE / ARMREST UNIT

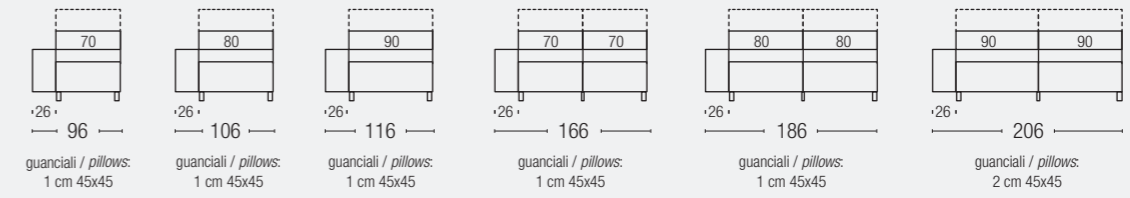

ANGOLO / CORNER

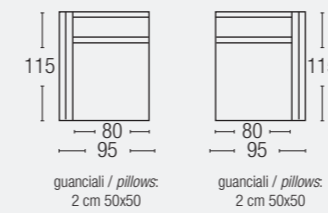

POUF

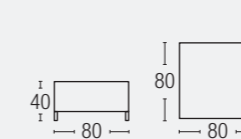

PIEDINI / FOOT



ELLE / ELLE FOOT

Cromato lucido / Polished chromed
h. 10 cm

BRACCIOLI / ARMREST



PLAY
DI SERIE/
STANDARD
Bracciolo 26 cm
Armrest 26 cm

PLAY LIGHT
A RICHIESTA/
ON REQUEST
Bracciolo 20 cm
Armrest 20 cm

PLAY ARMCHAIR
DI SERIE SULLA POLTRONA/
STANDARD ON ARMCHAIR
Bracciolo bombato 16 cm
Rounded armrest 16 cm



RALPH

Pagina 204

Design:
Danilo Bonfanti

STRUTTURA

Struttura in legno e multistrato imbottita in poliuretano a quote differenziate e rivestita in resinato accoppiato dello spessore di 10 mm.

MOLLEGGIO

Molleggio della seduta in nastri elastici intrecciati ad alta densità.

SEDUTA

Cuscini di seduta 100% in piuma naturale depolverizzata, lavata e sterilizzata a camere separate orizzontalmente e supportati da un inserto in poliuretano.

SCHIENALE

Cuscini schienale 50% in piuma naturale depolverizzata, lavata e sterilizzata, a camere separate orizzontalmente e 50% poliuretano; interamente rivestiti da una tela in cotone 100%.

GUANCIALI

Guanciali 100% piuma naturale lavata, depolverizzata e sterilizzata. Misura dei guanciali 45 X 45 cm.

STRUCTURE

Laminated wood structure padded with polyurethane foam of different densities and covered in a 10 mm layer of bonded resin.

SUSPENSION

The seat suspension system uses high-density intertwined elastic bands.

SEAT

Seat cushions made of 100% natural dust-free, washed and sterilized down padding arranged in separate horizontal chambers supported by a polyurethane insert.

BACKREST

Backrest cushions 50% natural dust-free, washed and sterilized down padding arranged in separate horizontal chambers and 50% polyurethane; 100% cotton fabric cover.

PILLOW

100% natural dust-free, washed and sterilized down Pillows. Pillow size 45 X 45 cm.

DIVANO / SOFA

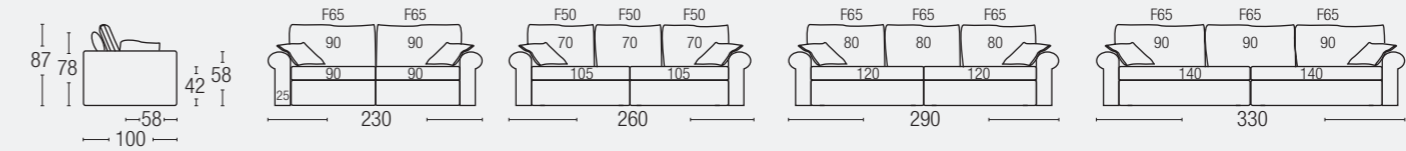

PENISOLA JOLLY / PENINSULA JOLLY

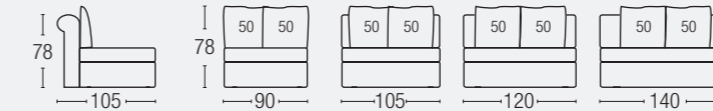

TERMINALE / ARMREST UNIT

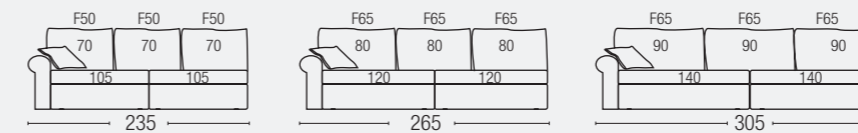
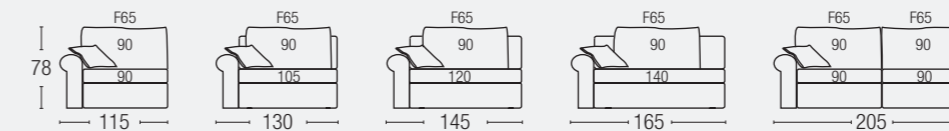

CHAISE LONGUE

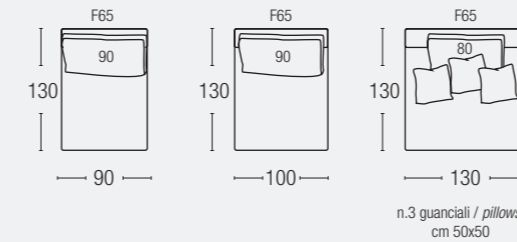

PIEDINI / FOOT



h 12,5 cm

F65-F50 / F65-F50



Sostegno cuscino schienale /
Backrest cushion support

F65 L.65 cm

F50 L.50 cm



Design:
Studio Archimeta

STRUTTURA

Struttura in legno e multistrato imbottita in poliuretano a quote differenziate e rivestita in resinato accoppiato dello spessore di 10 mm.

TELAIO

Telaio sotto i cuscini di seduta in multistrato per le versioni fisse.

SEDUTA - versione fissa

Cuscini di seduta in poliuretano densità minima 30 HR, con inserti centrali in molle, il tutto rivestito da una falda Dacron.

SEDUTA - versione letto

Cuscini di seduta in poliuretano densità minima 30 HR rivestiti da una falda Dacron.

SCHIENALE - sia versione letto che fissa

Cuscini schienale 50% in piuma naturale depolverizzata, lavata e sterilizzata - 50% poliuretano, a camere separate orizzontalmente interamente rivestiti da una tela in cotone 100%.

GUANCIALI

Guanciali 100% piuma naturale lavata, depolverizzata e sterilizzata. Misura dei guanciali 45 X 45 cm.

RETE E MATERASSO - versione letto

Rete a maglia elettrosaldata con materasso a molle altezza 15 cm.

S O F A - B E D



La profondità del divano con la rete aperta é di cm 217.

The depth of the sofa when the bed is open is 217 cm.

STRUCTURE

Laminated wood structure padded with polyurethane foam of different densities and covered in a 10 mm layer of bonded resin.

FRAME

Fixed versions are equipped with a plywood frame supporting the seat cushions.

SEAT - fixed version

Polyurethane padding seat cushions with a minimum density of 30 HR with central spring inserts, covered in a layer of Dacron.

SEAT - bed version

Polyurethane padding seat cushions with a minimum density of 30 HR covered in a layer of Dacron.

BACKREST - for both bed and fixed versions

Backrest cushions 50% natural dust-free, washed and sterilized Down padding – 50% Polyurethane arranged in separate horizontal chambers, 100% cotton fabric cover.

PILLOW

100% natural dust-free, washed and sterilized down Pillows. Pillow size 45 X 45 cm.

BED BASE AND MATTRESS - bed version

Electrowelded wire mesh bed base with a 15 cm spring mattress.

DIVANO / SOFA

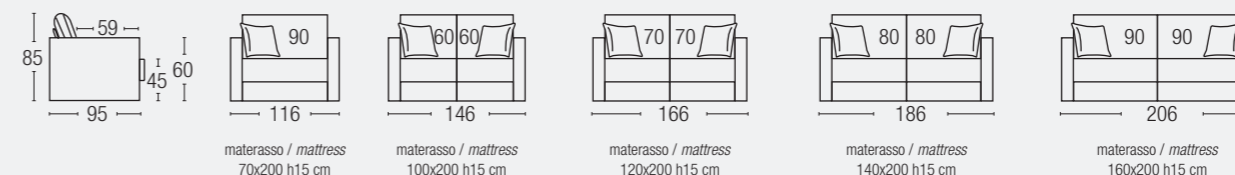

TERMINALE / ARMREST UNIT

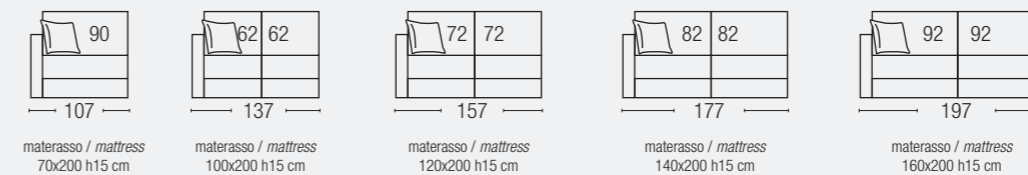

CHAISE LONGUE

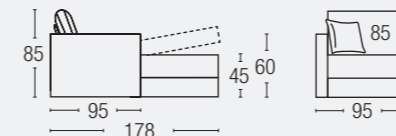

PIEDINI / FOOT

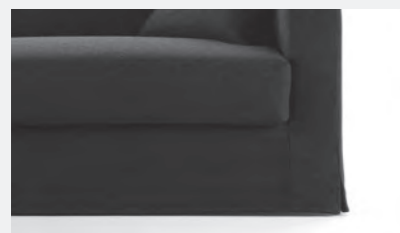

A SCOMPARSA / RETRACTABLE FOOT

Piede a scomparsa - versione fissa

Retractable foot - Fixed version

h. 5 cm

Piede a scomparsa - versione letto

Retractable foot - bed version

h. 8 cm



SILVER

Pagina 052

Design:
Danilo Bonfanti

STRUTTURA

Struttura in legno e multistrato imbottita in poliuretano a quote differenziate e rivestita in resinato accoppiato dello spessore di 10 mm.

MOLLEGGIO

Molleggio della seduta in nastri elastici intrecciati ad alta densità.

SEDUTA

Cuscini seduta 50% piuma naturale - 50% cin fill ball (fibra poliestere siliconata cava a pallino) con lastra memory foam, interamente rivestiti da una falda in Dacron supportati da una base in poliuretano.

SCHIENALE

Cuscini schienale 50% memory foam - 50% cin fill ball (fibra poliestere siliconata cava a pallino) a camere separate orizzontalmente interamente rivestiti da una tela in cotone 100%.

GUANCIALI

Guanciali 100% piuma naturale lavata, depolverizzata e sterilizzata. Misura dei guanciali 50 X 50 cm.

STRUCTURE

Laminated wood structure padded with polyurethane foam of different densities and covered in a 10 mm layer of bonded resin.

SUSPENSION

The seat suspension system uses high-density intertwined elastic bands.

SEAT

Seat cushions made of 50% natural feather - 50% Cin Fill Ball (silicone-coated hollow polyester fibre pellets) with memory foam layer, with a Dacron cover supported by a polyurethane base.

BACKREST

Backrest cushions 50% memory foam - 50% Cin Fill Ball (silicone-coated hollow polyester fibre pellets) arranged in separate horizontal chambers, 100% cotton fabric cover.

PILLOW

100% natural dust-free, washed and sterilized down Pillows. Pillow size 50 X 50 cm.

PIEDINI / FEET



PONTE NICK / PONTE NICK FOOT

Brunito / Burnished
Cromato lucido / Polished chromed
Satinato / Satin
h. 15 cm
A richiesta / On request:
- RAL verniciato opaco / Matt RAL varnished



SPILLO NICK / SPILLO NICK FOOT

Brunito / Burnished
Cromato lucido / Polished chromed
Satinato / Satin
h. 15 cm
A richiesta / On request:
- RAL verniciato opaco / Matt RAL varnished



DOPPIA LAMINA / DOPPIA LAMINA FOOT

Cromato lucido / Polished chromed
h. 15 cm

BRACCIOLI / ARMREST



Bracciolo 15 cm
Armrest 15 cm



Bracciolo 25 cm
Armrest 25 cm

ACCESSORI / ACCESSORIES



PIANO VASSOIO IN MDF / PLAN-TRAY IN MDF

Disponibile nei colori / Available in
RAL 7001/7030/9003

DIVANO / SOFA

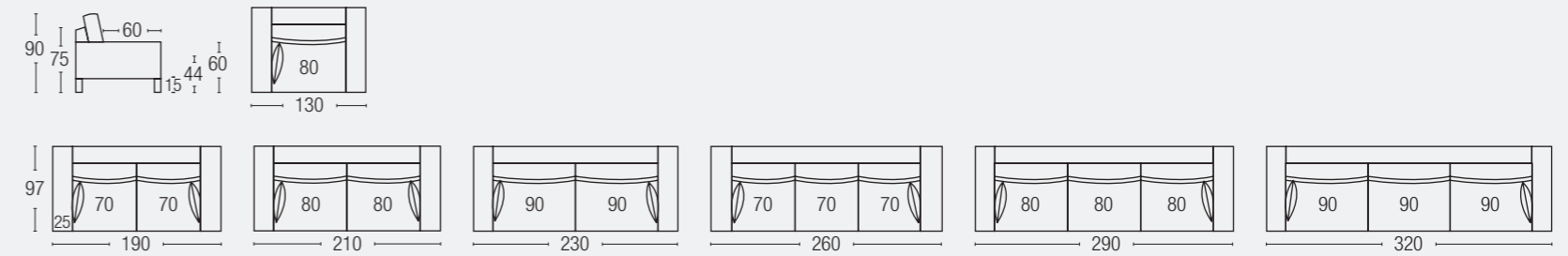

TERMINALE / ARMREST UNIT

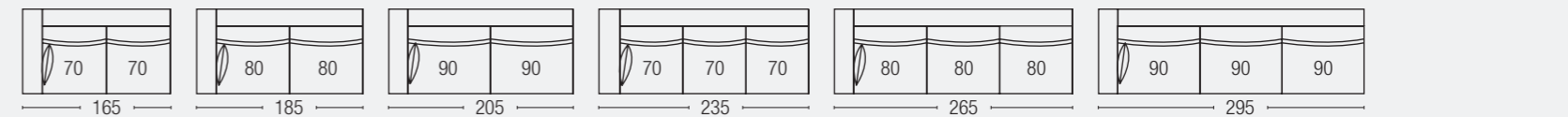

PENISOLA / PENINSULA

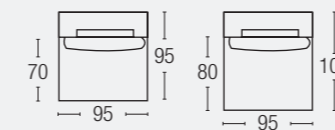

CHAISE LOUNGE

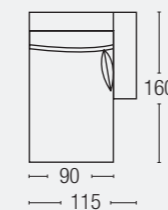

PANCA / BENCH

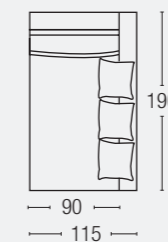

ANGOLO / CORNER

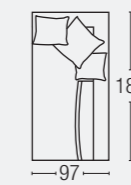

guanciali / pillows:
1 cm 65x65 - 2 cm 50x50

ANGOLO / CORNER

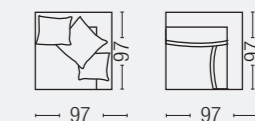

POUF

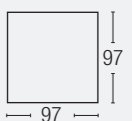

ELEMENTI CON CUSCINO-COFFEE TABLE
ELEMENTS WITH CUSHION-COFFEE TABLE

TERMINALE CON POUF / ARMREST UNIT WITH POUF*

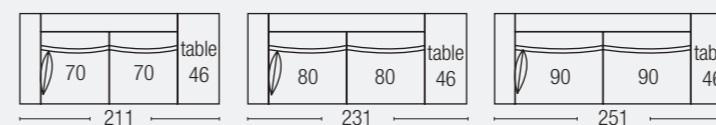

PENISOLA / PENINSULA

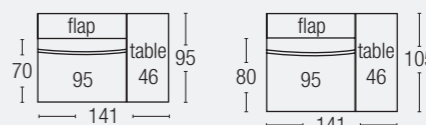

ANGOLARE CON POUF / CORNER WITH POUF

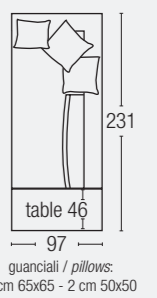

guanciali / pillows:
1 cm 65x65 - 2 cm 50x50

ESEMPI DI CONFIGURAZIONI CONFIGURATIONS EXAMPLES

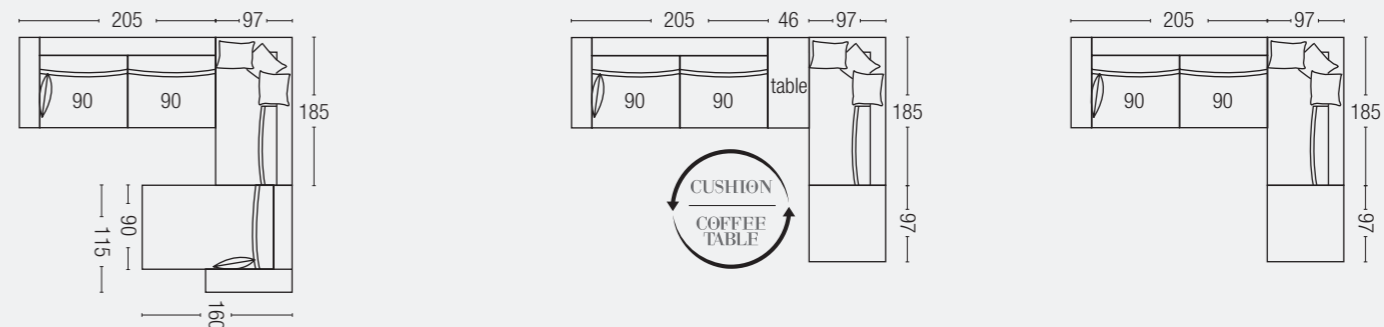

SURF

Pagina 224



Design:
Studio Archimeta

S O F A - B E D



La seduta corrisponde al materasso superiore e non sporge rispetto alla profondità del divano; la rete inferiore è mobile e può essere separata dal divano.

The seat coincides with the upper mattress and doesn't protrude in relation to the depth of the sofa; the lower base is mobile and can be separated from the sofa.

DIVANO / SOFA

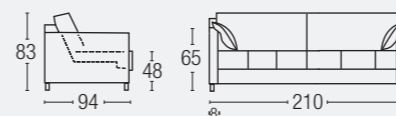

STRUTTURA

Struttura in legno e multistrato imbottita in poliuretano a quote differenziate e rivestita in resinato accoppiato dello spessore di 10 mm.

SCHIENALE

Cuscini schienale 100% in piuma naturale depolverizzata, lavata e sterilizzata, a camere separate orizzontalmente, con inserto in poliuretano interamente rivestiti da una tela in cotone 100%.

GUANCIALI

Guanciali 100% piuma naturale lavata, depolverizzata e sterilizzata. Misura dei Guanciali 40 X 40 cm.

MATERASSO

MATERASSO SUPERIORE: a molle 80x190x15 cm (serve anche come cuscino di seduta)
MATERASSO INFERIORE: a molle 75x188x15 cm

RETE

Rete a maglia elettrosaldata.

STRUCTURE

Laminated wood structure padded with polyurethane foam of different densities and covered in a 10 mm layer of bonded resin.

BACKREST

Backrest cushions 100% natural dust-free, washed and sterilized down padding arranged in separate horizontal chambers with a polyurethane insert and 100% cotton fabric cover.

PILLOW

100% natural dust-free, washed and sterilized down Pillows. Pillow size 40 X 40 cm.

MATTRESS

UPPER MATTRESS:

With springs 80 X 190 X 15 cm (it is also employed as a seat cushion)

LOWER MATTRESS:

With springs 75 X 188 X 15 cm

BED BASE

Electrowelded wire mesh bed base.

PIEDINI / FOOT



CILINDRO / CILINDRO FOOT

Cromato lucido / Polished chromed
h. 8 cm



WIND

Pagina 022

STRUTTURA

Struttura in legno e multistrato imbottita in poliuretano a quote differenziate e rivestita in resinato accoppiato dello spessore di 10 mm.

MOLLEGGIO

Molleggio della seduta in nastri elastici intrecciati ad alta densità.

SEDUTA

Cuscini di seduta in poliuretano densità minima 30 HR rivestiti da una falda Dacron.

SCHIENALE

Cuscini schienale 50% cin fill ball (fibra poliestere siliconata cava a pallino) - 50% memory foam, a camere separate orizzontalmente interamente rivestiti da una tela in cotone 100%.

STRUCTURE

Laminated wood structure padded with polyurethane foam of different densities and covered in a 10 mm layer of bonded resin.

SUSPENSION

The seat suspension system uses high-density intertwined elastic bands.

SEAT

Polyurethane padding seat cushions with a minimum density of 30 HR covered in a layer of Dacron.

BACKREST

Backrest cushions 50% Cin Fill Ball (silicone-coated hollow polyester fibre pellets) 50% Memory Foam arranged in separate horizontal chambers, 100% cotton fabric cover.

PIEDINI / FOOT

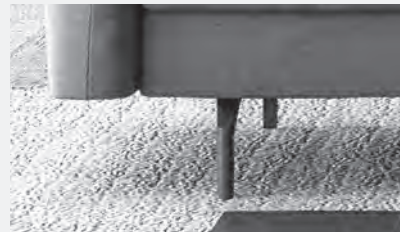

SMERALDO / SMERALDO FOOT

Alluminio cromato / Chromed aluminum
Brunito / Burnished
Satinato / Satin
h 15 cm



PONTE NICK / PONTE NICK FOOT

Brunito / Burnished
Cromato lucido / Polished chrome
Satinato / Satin
h 15 cm

SCHIENALE / BACKREST



Senza cuciture
Stitchingless



Con cuciture
With stitchings

BRACCIOLI / ARMREST



Bracciolo regolabile / Adjustable armrest

Misura di massimo ingombro a bracciolo chiuso cm 20
Maximum dimensions with closed armrest cm 20
Misura di massimo ingombro a bracciolo aperto cm 37
Maximum dimensions with open armrest cm 37.

SCHIENALE / BACKREST



Schienale regolabile / Adjustable backrest

Profondità a schienale chiuso cm 100
Depth with closed backrest cm 100
Profondità a schienale aperto cm 110
Depth with open backrest cm 110.

DIVANO / SOFA

misure di massimo ingombro a bracciolo chiuso / maximum dimensions with closed armrest

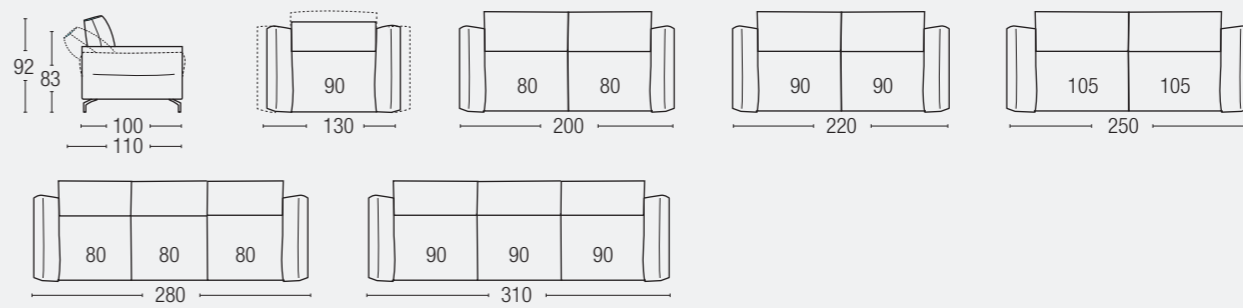

TERMINALE / ARMREST UNIT

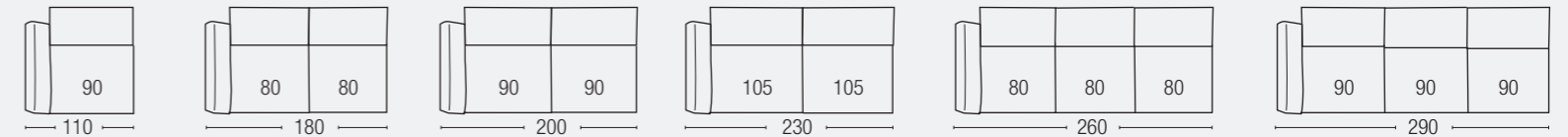

CHAISE LOUNGUE

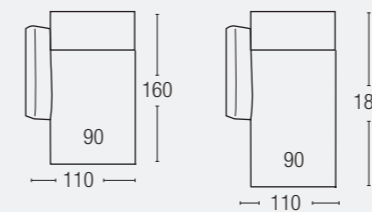

ISOLA / ISLE

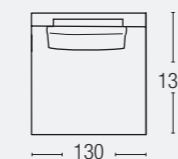

ANGOLO / CORNER

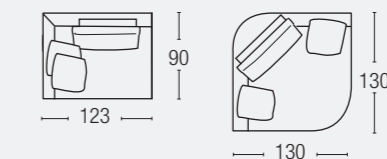

POUF

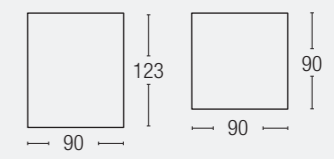

ESEMPI DI CONFIGURAZIONI CONFIGURATIONS EXAMPLES

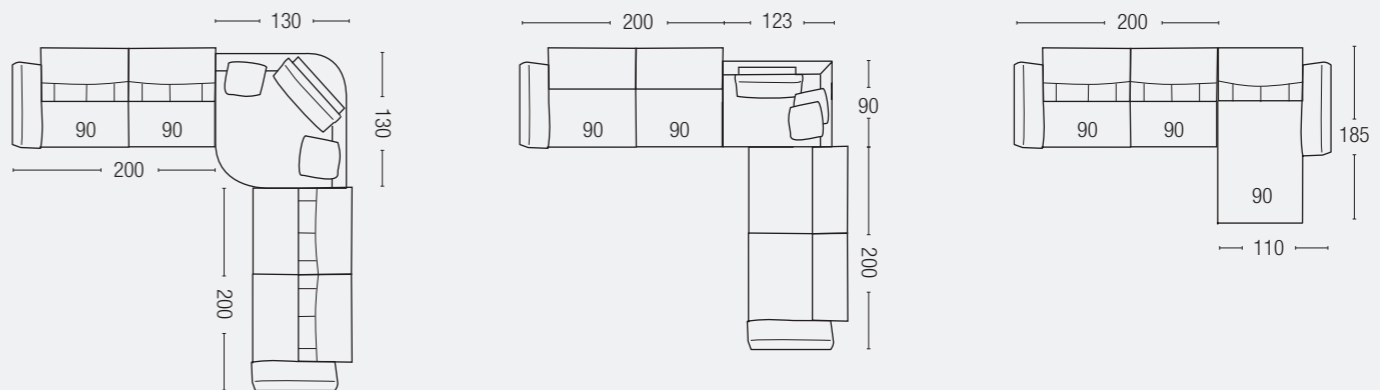



ZENO

Pagina 128

Design:
Danilo Bonfanti

STRUTTURA

Struttura in legno e multistrato imbottita in poliuretano a quote differenziate e rivestita in resinato accoppiato dello spessore di 10 mm.

MOLLEGGIO

Molleggio della seduta in nastri elastici intrecciati ad alta densità.

SEDUTA

Cuscini di seduta in poliuretano densità minima 30 HR rivestiti da una falda Dacron.

SCHIENALE

Schienale Standard: cuscini 50% in piuma naturale depolverizzata, lavata e sterilizzata - 50% poliuretano, a camere separate orizzontalmente interamente rivestiti da una tela in cotone 100%.

Schienale su richiesta: cuscini 50% in memory foam - 50% poliuretano a camere separate orizzontalmente interamente rivestiti da una tela in cotone 100%.

STRUCTURE

Laminated wood structure padded with polyurethane foam of different densities and covered in a 10 mm layer of bonded resin.

SUSPENSION

The seat suspension system uses high-density intertwined elastic bands.

SEAT

Polyurethane padding seat cushions with a minimum density of 30 HR covered in a layer of Dacron.

BACKREST

Standard backrest: cushions 50% natural dust-free, washed and sterilized Down padding - 50% Polyurethane arranged in separate horizontal chambers, 100% cotton fabric cover.

Backrest on request: backrest cushions 50% memory foam - 50% polyurethane arranged in separate horizontal chambers, 100% cotton fabric cover.

PIEDINI / FOOT

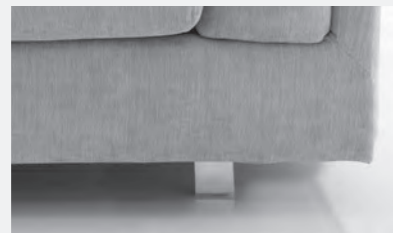

LAMINA / LAMINA FOOT

Satinato / Satin
Brunito / Burnished
h. 7,5 cm
A richiesta / On request
h.9,5 cm

QUADRATO / SQUARE FOOT

A sezione quadrata / Square section
h.7,5 cm
A richiesta / On request
h.9,5 cm

ZENO PLUS



DIVANO ZENO
ZENO SOFA

+



=



BASE POUF
POUF BASE
DX / SX

+



=



CUSCINO POUF
PILLOW POUF
DX / SX



Guarda il video
Watch the video

DIVANO / SOFA

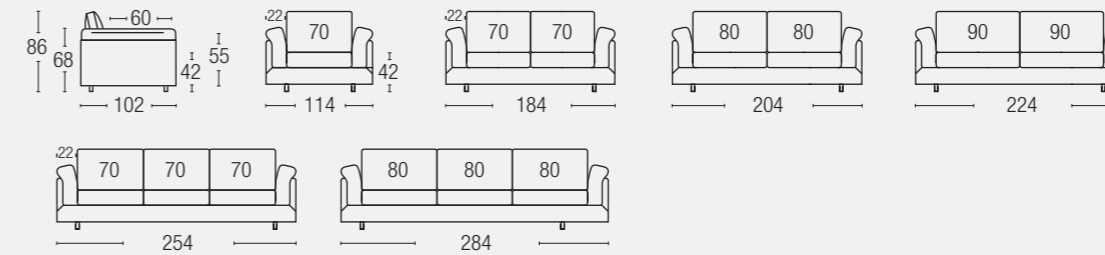

TERMINALE / ARMREST UNIT



POUF

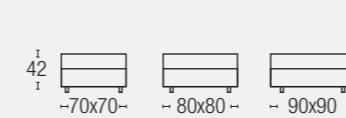

CHAISE LONGUE

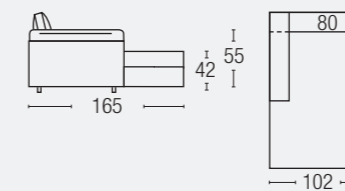

ANGOLO / CORNER

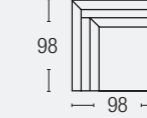

PENISOLA REVERSIBILE / REVERSIBLE PENINSULA

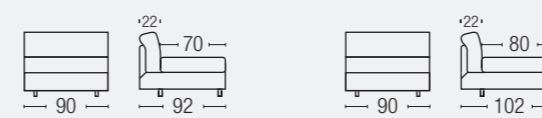

ZENO PLUS

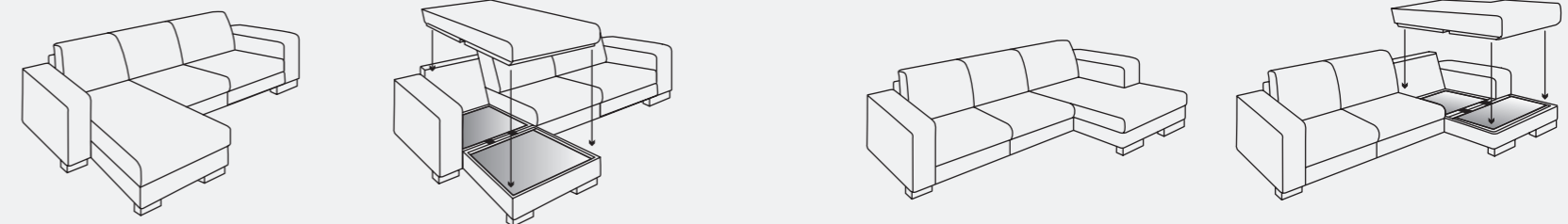

COMPOSIZIONE REVERSIBILE / REVERSIBLE COMPOSITION

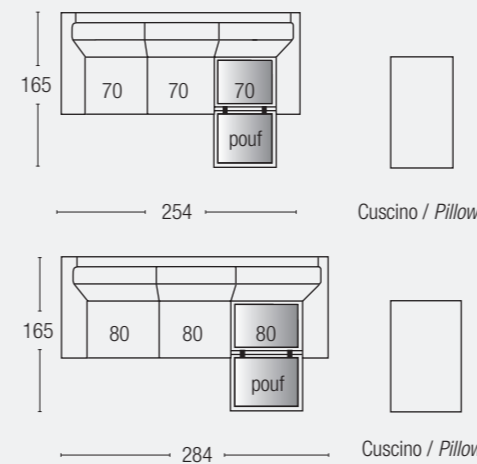

COMPOSIZIONE DX-SX / RIGHT-LEFT COMPOSITION

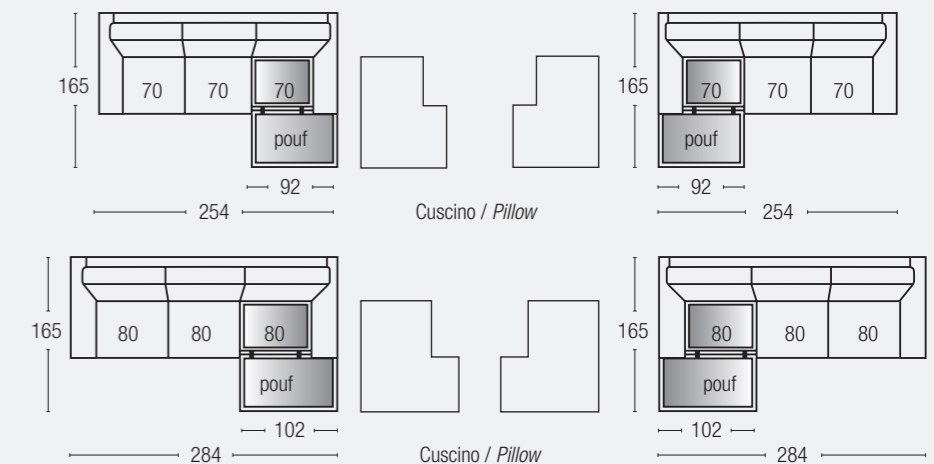



ADELAIDE

Pagina 180

POLTRONA / ARMCHAIR

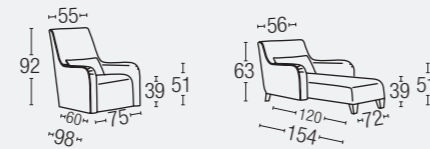

STRUTTURA

Struttura in legno e multistrato imbottita in poliuretano a quote differenziate e rivestita in resinato accoppiato dello spessore di 10 mm.

GUANCIALE

Guanciale 100% piuma naturale, lavata, depolverizzata e sterilizzata. Misura del guanciale 45 X 30 cm.

TELAIO

Telaio sotto i cuscini di seduta in multistrato.

PIEDINO

La poltrona H 92 ha un piedino di cm 4 di H fisso o girevole.
La poltrona H 63 ha un Piedino di cm 14 di H color Wengé.

SEDUTA

Cuscini di seduta in poliuretano densità minima 30 HR rivestiti da una falda Dacron.

STRUCTURE

Laminated wood structure padded with polyurethane foam of different densities and covered in a 10 mm layer of bonded resin.

PILLOW

100% natural dust-free, washed and sterilized down Pillows. Pillow size 45 X 30 cm.

FRAME

Plywood frame supporting the seat cushions.

FOOT

The H 92 armchair has 4 cm fixed or swivel foot.
The H 63 armchair has 14 cm Wengé wood coloured foot.

SEAT

Polyurethane padding seat cushions with a minimum density of 30 HR covered in a layer of Dacron.

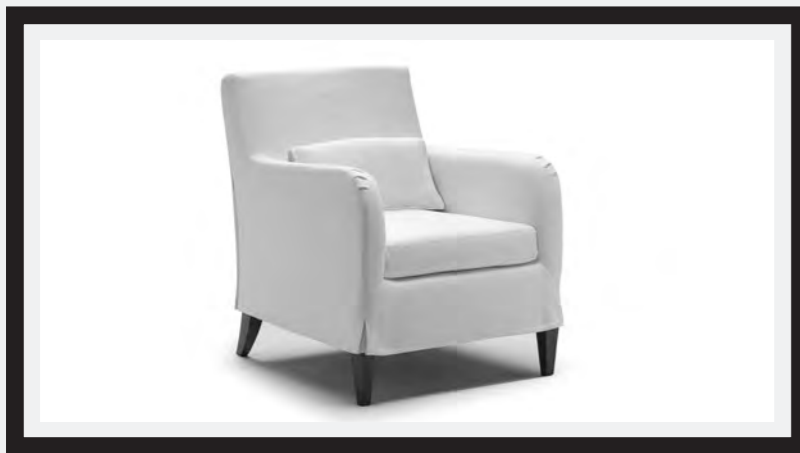

CLOPINNE

Pagina 198

POLTRONA / ARMCHAIR

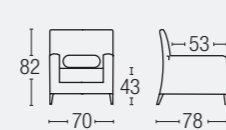

STRUTTURA

Struttura in legno e multistrato imbottita in poliuretano a quote differenziate e rivestita in resinato accoppiato dello spessore di 10 mm.

SEDUTA

Cuscini di seduta in poliuretano densità minima 30 HR rivestiti da una falda Dacron.

PIEDINO

Piedi di serie colore faggio naturale.

MOLLEGGIO

Molleggio della seduta in nastri elastici intrecciati ad alta densità.

STRUCTURE

Laminated wood structure padded with polyurethane foam of different densities and covered in a 10 mm layer of bonded resin.

SEAT

Polyurethane padding seat cushions with a minimum density of 30 HR covered in a layer of Dacron.

SUSPENSION

The seat suspension system uses high-density intertwined elastic bands.

FOOT

Standard natural beechwood-coloured foot.



FROG

Pagina 098

Design:
Danilo Bonfanti

POLTRONA / ARMCHAIR

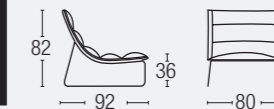

POUF

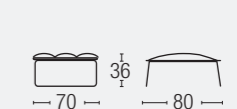

STRUTTURA

Struttura in legno e multistrato imbottita in poliuretano a quote differenziate e rivestita in resinato accoppiato dello spessore di 10 mm.

BASAMENTO

Struttura metallo cromato lucido.

MOLLEGGIO

Molleggio della seduta in nastri elastici intrecciati ad alta densità.

SEDUTA

Inserti seduta in poliuretano densità minima 30 HR rivestiti da una falda di Dacron.

STRUCTURE

Laminated wood structure padded with polyurethane foam of different densities and covered in a 10 mm layer of bonded resin.

BASE

Polished chrome covering base.

SUSPENSION

The seat suspension system uses high-density intertwined elastic bands.

SEAT

Polyurethane padding seat cushions with a minimum density of 30 HR covered in a layer of Dacron.

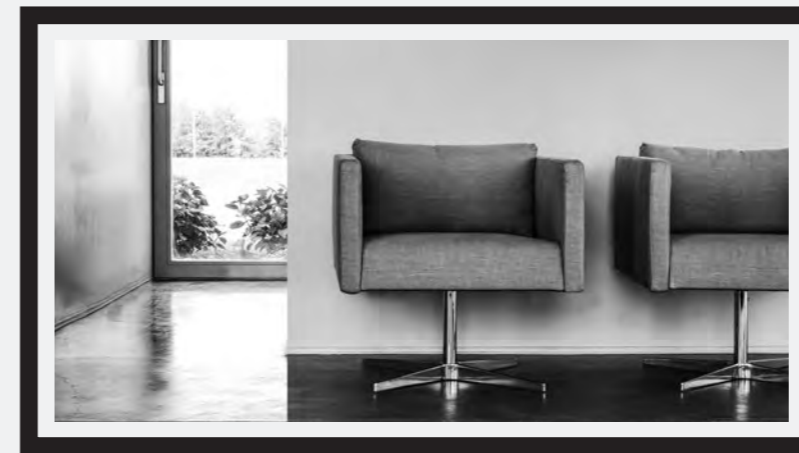

MAX

Pagina 136

Design:
Studio Archimeta

POLTRONA / ARMCHAIR

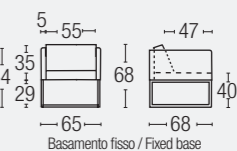
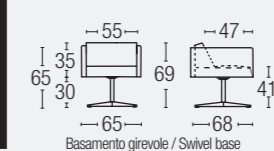

STRUTTURA

Struttura in legno e multistrato imbottita in poliuretano a quote differenziate e rivestita in resinato accoppiato dello spessore di 10 mm.

SCHIENALE

Cuscino schienale in poliuretano densità 25 HR rivestito da una falda di Dacron.

BASAMENTO

GIREVOLE: metallo cromato lucido, H 28 cm
FISSO: metallo cromato lucido, H 29 cm
A richiesta colore RAL verniciato opaco.

SEDUTA

Cuscini di seduta in poliuretano densità minima 30 HR rivestiti da una falda Dacron.

STRUCTURE

Laminated wood structure padded with polyurethane foam of different densities and covered in a 10 mm layer of bonded resin.

BACKREST

Polyurethane padding backrest cushions with a minimum 25 HR density covered in a layer of Dacron.

FRAME

Plywood frame supporting the seat cushions.

SEAT

Polyurethane padding seat cushions with a minimum density of 30 HR covered in a layer of Dacron.

BASE

SWIVEL: H 28 cm polished chrome covering base
FIXED: H 29 cm polished chrome covering base
Available on request: matt RAL varnished base



NOAH

Pagina 082

Design:
Danilo Bonfanti

CHAISE LONGUE / CHAISE LONGUE

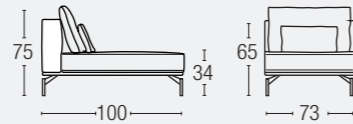

STRUTTURA

Struttura in legno e multistrato imbottita in poliuretano a quote differenziate e rivestita in resinato accoppiato dello spessore di 10 mm.

PIEDINO

Piede H.18 cm in metallo cromato, brunito, cartella Ral

SEDUTA

Cuscini di seduta in poliuretano densità minima 30 HR rivestiti da una falda Dacron Politex termosaldato.

STRUCTURE

Laminated wood structure padded with polyurethane foam of different densities and covered in a 10 mm layer of bonded resin.

FOOT

Foot h.18 metal chrome, burnished, Ral

SEAT

Polyurethane padding seat cushions with a minimum density of 30 HR covered in a layer of thermosealed Dacron Politex.



TAG

Pagina 070

Design:
Danilo Bonfanti

POLTRONA / ARMCHAIR

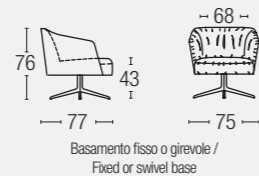

STRUTTURA

Struttura in legno e multistrato imbottita in poliuretano a quote differenziate e rivestita in resinato accoppiato dello spessore di 10 mm.

BASAMENTO

Fisso o girevole in metallo, finitura bronzata, altezza 28 cm.

TELAIO

Telaio sotto i cuscini di seduta in multistrato.

SEDUTA

Cuscini di seduta in poliuretano densità minima 30 HR rivestiti da una falda Dacron.

STRUCTURE

Laminated wood structure padded with polyurethane foam of different densities and covered in a 10 mm layer of bonded resin.

BASE

Fixed or swivel metal base, bronze finished, H 28 cm.

FRAME

Plywood frame supporting the seat cushions.

SEAT

Polyurethane padding seat cushions with a minimum density of 30 HR covered in a layer of Dacron.



WILLY

Pagina 199

POLTRONA / ARMCHAIR

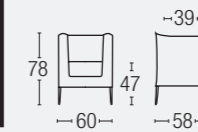

STRUTTURA

Struttura in legno e multistrato imbottita in poliuretano a quote differenziate e rivestita in resinato accoppiato dello spessore di 10 mm.

PIEDINO

Piedi di serie colore faggio naturale.

MOLLEGGIO

Molle della seduta in nastri elastici intrecciati ad alta densità.

SEDUTA

Cuscini di seduta in poliuretano densità minima 30 HR rivestiti da una falda Dacron.

STRUCTURE

Laminated wood structure padded with polyurethane foam of different densities and covered in a 10 mm layer of bonded resin.

FOOT

Standard natural beechwood-coloured foot.

SUSPENSION

The seat suspension system uses high-density intertwined elastic bands.

SEAT

Polyurethane padding seat cushions with a minimum density of 30 HR covered in a layer of Dacron.



ZIP

Pagina 016

Design:
Danilo Bonfanti

POLTRONA E DIVANETTO / ARMCHAIR AND SOFA

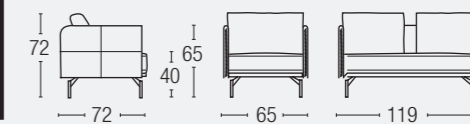

STRUTTURA

Struttura in legno e multistrato imbottita in poliuretano a quote differenziate e rivestita in resinato accoppiato dello spessore di 10 mm.

PIEDINO

Piede H.23 cm in metallo cromato, brunito, cartella Ral

SEDUTA

Cuscini di seduta in poliuretano densità minima 30 HR rivestiti da una falda Dacron Politex termosaldato.

STRUCTURE

Laminated wood structure padded with polyurethane foam of different densities and covered in a 10 mm layer of bonded resin.

FOOT

Foot h.23 metal chrome, burnished, Ral

SEAT

Polyurethane padding seat cushions with a minimum density of 30 HR covered in a layer of thermosealed Dacron Politex.



BON BON

Pagina 112

POUF

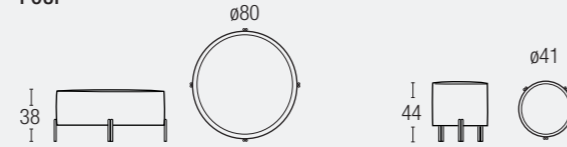

STRUTTURA

Struttura in legno e multistrato imbottita in poliuretano a quote differenziate e rivestita in resinato accoppiato dello spessore di 10 mm.

MOLLEGGIO

Molleggio della seduta in nastri elastici intrecciati ad alta densità.

SEDUTA

Seduta in poliuretano densità minima 30 HR rivestita in vellutino accoppiato spessore 10mm.

PIEDINO

Piede H.17 cm in metallo cromato, brunito, cartella Ral

STRUCTURE

Laminated wood structure padded with polyurethane foam of different densities and covered in a 10 mm layer of bonded resin.

SUSPENSION

The seat suspension system uses high-density intertwined elastic bands.

FOOT

Foot h.17 metal chrome, burnished, Ral

SEAT

Polyurethane padding seat cushions with a minimum density of 30 HR



DISCOVERY

Pagina 114

Design:
Danilo Bonfanti

POUF

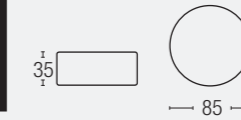

STRUTTURA

Struttura in legno e multistrato imbottita in poliuretano a quote differenziate e rivestita in resinato accoppiato dello spessore di 10 mm.

MOLLEGGIO

Molleggio della seduta in nastri elastici intrecciati ad alta densità.

SEDUTA

Cuscini di seduta in poliuretano densità minima 30 HR rivestiti da una falda Dacron.

PIEDINO

Piede a scomparsa, altezza 3 cm.

STRUCTURE

Laminated wood structure padded with polyurethane foam of different densities and covered in a 10 mm layer of bonded resin.

SUSPENSION

The seat suspension system uses high-density intertwined elastic bands.

SEAT

Polyurethane padding seat cushions with a minimum density of 30 HR covered in a layer of Dacron.

FOOT

Retractable foot – H 3 cm.



BON TON

Pagina 110

POUF

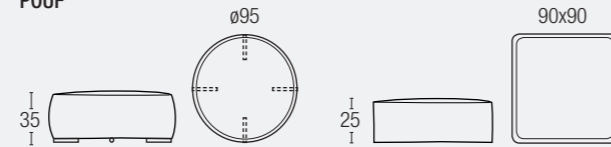

STRUTTURA

Struttura in legno e multistrato imbottita in poliuretano a quote differenziate e rivestita in resinato accoppiato dello spessore di 10 mm.

MOLLEGGIO

Molleggio della seduta in nastri elastici intrecciati ad alta densità.

SEDUTA

Seduta in poliuretano densità minima 30 HR rivestiti da una falda Dacron Politex termosaldato.

PIEDINO

Piede per pouf tondo: Valle

STRUCTURE

Laminated wood structure padded with polyurethane foam of different densities and covered in a 10 mm layer of bonded resin.

SUSPENSION

The seat suspension system uses high-density intertwined elastic bands.

FOOT

Valle foot: only for round pouf.

SEAT

Polyurethane padding seat cushions with a minimum density of 30 HR covered in a layer of thermosealed Dacron Politex.



POUF

Pagina 117

PUFFO

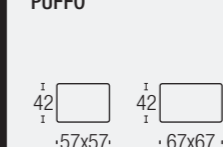

PUFFO LINE

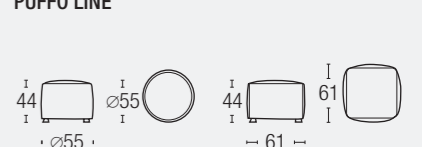

STRUTTURA

Struttura in legno e multistrato imbottita in poliuretano a quote differenziate e rivestita in resinato accoppiato dello spessore di 10 mm.

MOLLEGGIO

Molleggio della seduta in nastri elastici intrecciati ad alta densità.

SEDUTA

Seduta in poliuretano densità minima 30 HR rivestiti da una falda Dacron.

PIEDINO

Piede a scomparsa, altezza 3 cm.

STRUCTURE

Laminated wood structure padded with polyurethane foam of different densities and covered in a 10 mm layer of bonded resin.

SUSPENSION

The seat suspension system uses high-density intertwined elastic bands.

SEAT

Polyurethane padding seat cushions with a minimum density of 30 HR covered in a layer of Dacron.

FOOT

Retractable foot – H 3 cm.



BIPLANO

Pagina 034

Design:
Arch. Danilo Bonfanti

TAVOLINO / COFFEE TABLE

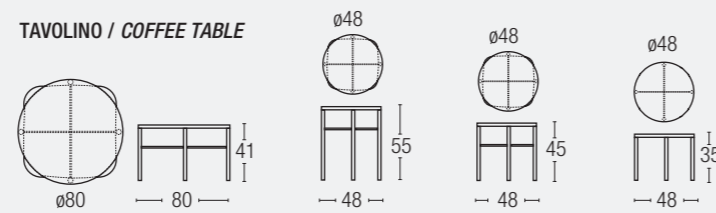

STRUTTURA

Struttura in metallo verniciato.
Disponibile nei colori Grigio e Brunito.

FRAME

Frame in varnished metal
Available in grey and burnished color options

PIANI

Top rovere oppure laccato.
Ripiano in vetro retroverniciato.

TOP

Oak or lacquered wood top
Back-painted glass shelf



PONTE

Pagina 050

Design:
Danilo Bonfanti

TAVOLINO / COFFEE TABLE

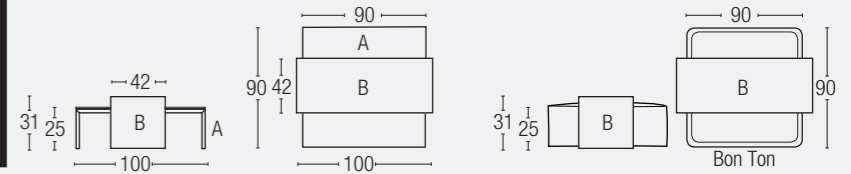

STRUTTURA

A . Struttura in metallo verniciato.
Disponibile nei colori Grigio e Brunito.
B . Struttura e piano in Rovere oppure laccato.

FRAME

A . Varnished metal frame
Available in grey and burnished color options
B . Oak or lacquered wood frame and top

PIANO

A . Piano in vetro retroverniciato.

TOP

A . Back-painted glass top

I tavolini Ponte nelle versioni A e B sono disponibili anche singolarmente.
The Ponte coffee tables in Frame Versions A and B are also available individually

E' possibile combinare il tavolino Ponte B con il pouf Bon Ton (pag.308)
You can combine the Ponte coffee table Frame B with the Bon Ton pouf (page 308)



BREAK

Pagina 086

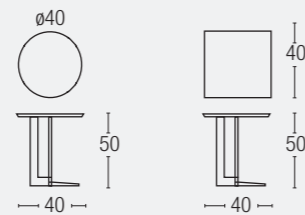

STRUTTURA

Struttura in metallo laccato opaco manganese
Disponibile nei colori Grigio e Brunito.

FRAME

Opaque manganese lacquered metal frame
Available in grey and burnished color options

PIANI

Top rovere, laccato o vetro retroverniciato.
Disponibile nei formati tondo o quadrato.

TOP

Oak wood / lacquered wood / back-painted glass top.
Available with square or round top



TRIS

Pagina 051

Design:
Danilo Bonfanti

TAVOLINO / COFFEE TABLE

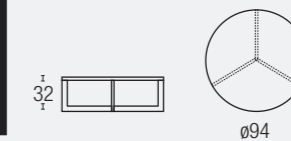

STRUTTURA

Struttura in metallo verniciato.
Disponibile nei colori Grigio e Brunito

FRAME

Varnished metal frame
Available in grey and burnished color options

PIANI

Piano rovere, laccato, gres porcellanato,
vetro retroverniciato.

TOP

Oak wood / lacquered wood / porcelain stoneware / back-painted glass top

AD: Danilo Bonfanti, architetto

Photo, layout e 3D: Studio Target - Lazzate (MB)

Styling: Roberta Mari

La ditta si riserva il diritto di apportare in ogni momento modifiche tecniche ed estetiche.

The company reserves the right to change, at any time and without prior warning, the technical specifications and dimension of the articles.

La stampa tipografica non sempre permette la fedele riproduzione dei colori e delle tinte rispetto agli originali.

The printing process doesn't always permit a faithful reproduction of colours and tones as compared to the original.

biba
S A L O T T I



www.bibasalotti.it

BIBA SALOTTI s.r.l.: Via Spezia, 187- 43126 Parma - Italy - Tel. +39 0521.293002 - Fax +39 0521.292921 - sales@bibasalotti.com